

The logo consists of the letters 'D' and 'M' in a stylized, red, serif font, positioned one above the other within a white square.

DECOMASTER

БАГЕТ



БАГЕТ

ДЕТАЛИ КАЖДОЙ СОВЕРШЕНСТВО

Компания DECOMASTER в течение 17 лет работает на российском рынке элементов оформления интерьера и отделочных материалов и за это время зарекомендовала себя как производитель и импортер качественной и востребованной продукции. Являясь лидерами на рынке декоративно-отделочных материалов, мы предлагаем Вашему вниманию богатую коллекцию рамного багета.

Багет DECOMASTER производится из экологически чистого материала – полистирола высокой плотности. Этот современный материал не деформируется со временем, не дает усадки, не впитывает запахи и не боится влажности.

Палитра багетов DECOMASTER отличается широким разнообразием и может служить неисчерпаемым источником вдохновения. Здесь Вы найдете как благородные классические оттенки серебра, золота, бронзы и дерева, так и современные цветовые решения. Вы сможете подобрать багет различных стилистических направлений: и старинные рамы различных эпох, и рамы в стилях кантри, модерн, техно и других для воплощения любых идей в оформлении пространства.

Большой выбор форм, цветов и размеров позволяет применять багет не только для традиционного оформления картин, зеркал, вышивок и фотографий. Современным трендом является смешение стилей и использование нешаблонных дизайнерских приемов. Багет DECOMASTER можно применить для обрамления практически любой детали интерьера, требующей завершения, – декорировать красивой багетной рамой телевизор, аквариум, художественную вставку на обоях или подчеркнуть сочетание разных оттенков декоративной штукатурки, стеновых панелей. Можно украсить двери, предметы мебели или кессонный потолок, сделать оригинальные карнизы для штор.

Багет DECOMASTER придаст изысканности и элегантности, позволит добавить тот самый финальный штрих, который сделает Ваш интерьер уникальным.





коллекция

РЕНЕССАНС



947-565

947-566

947-954

947-956

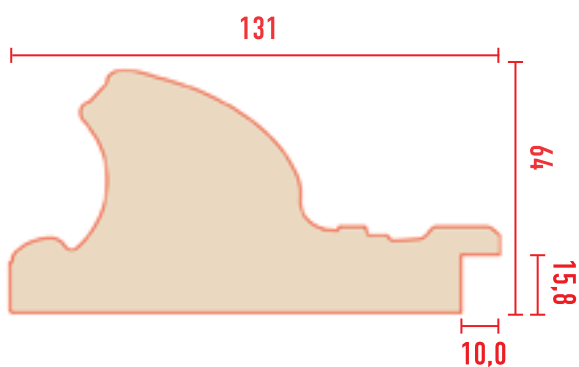



S16-1223

S16-966

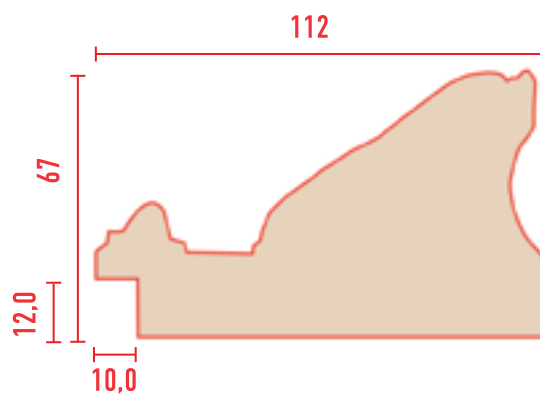



коллекция

РЕНЕССАНС



230-966



230-1223

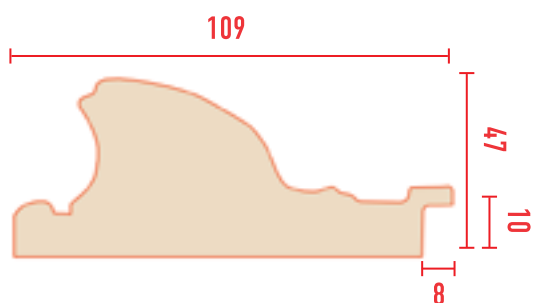



980-565



980-566

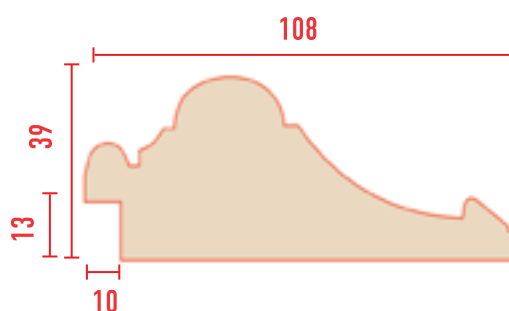



коллекция

РЕНЕССАНС



229-1223



229-966



229-645



229-955

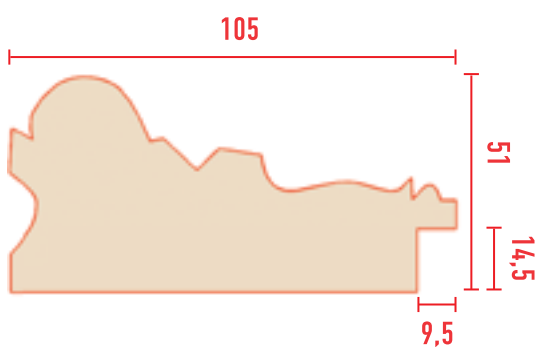



229-1068

229-182

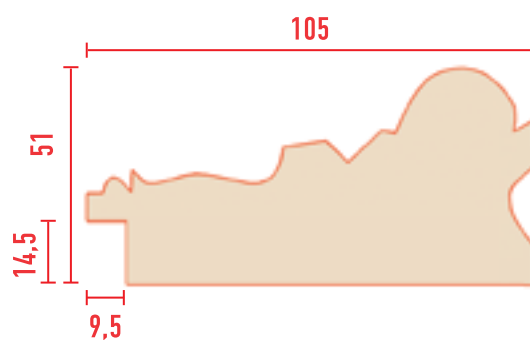



коллекция

РЕНЕССАНС



400-958



400-954



400-956

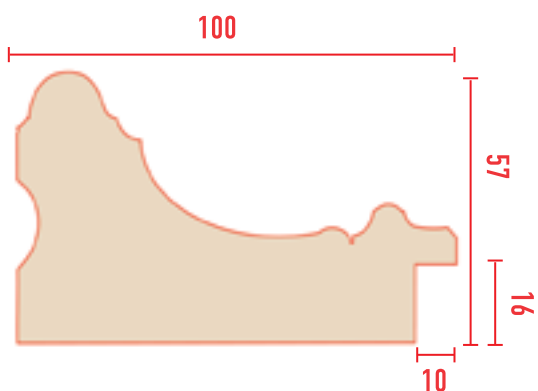

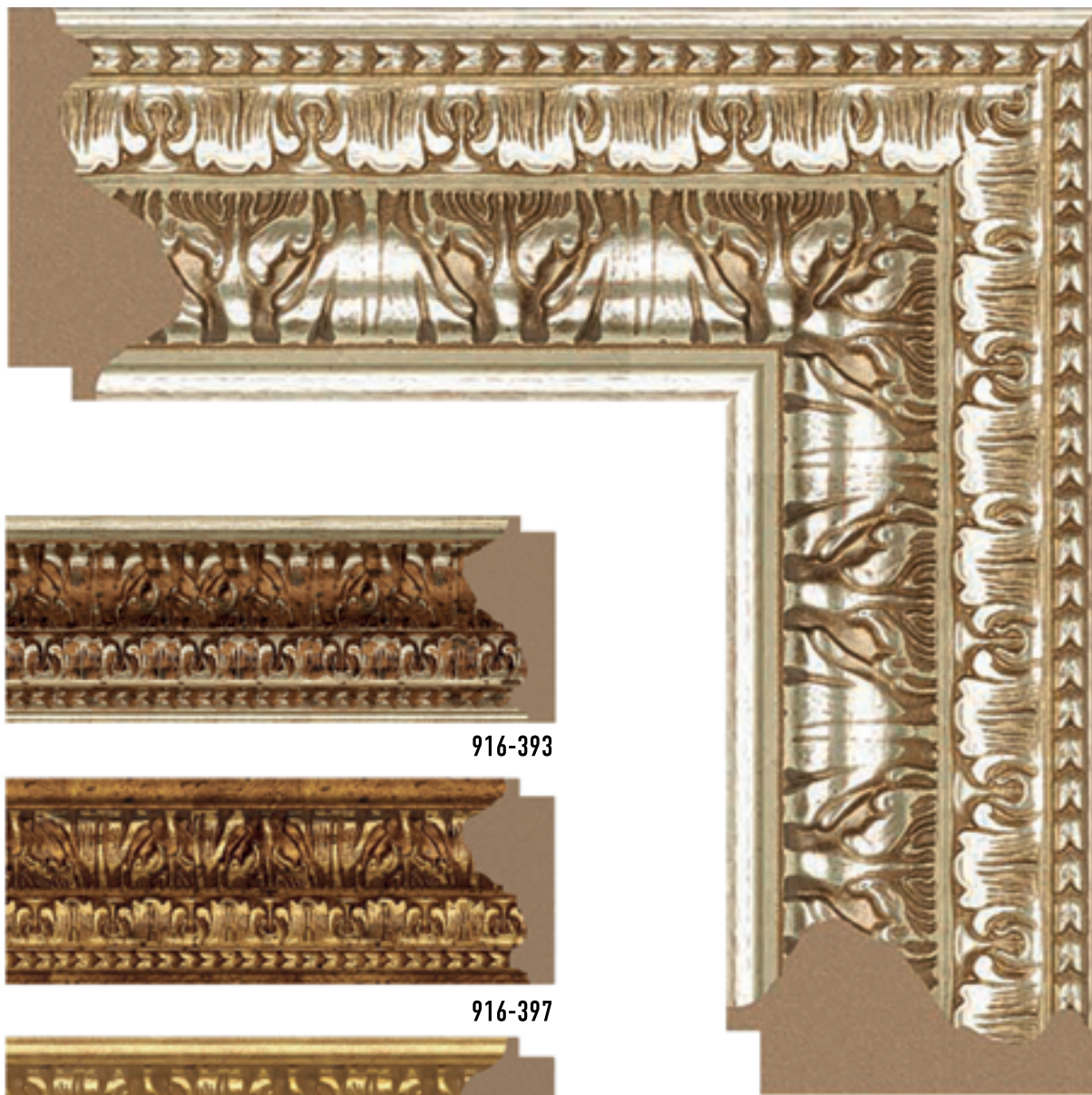

916-393



916-397



916-461

916-247

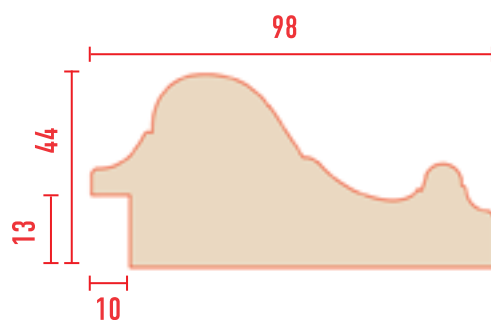



коллекция

РЕНЕССАНС



214-3

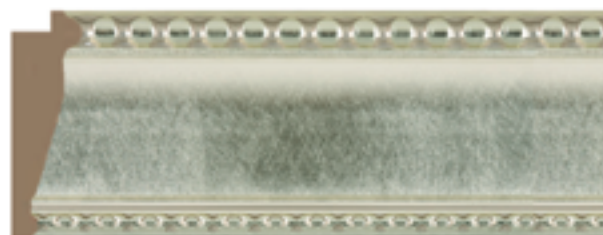

214-373



214-6

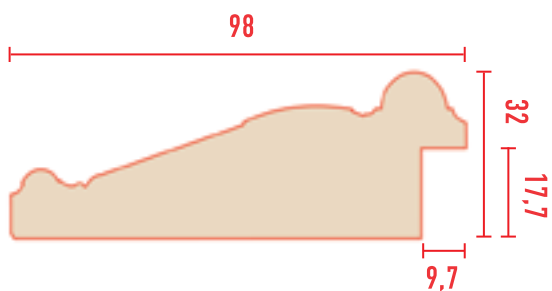



413-565



413-494



413-919



413-182



413-566

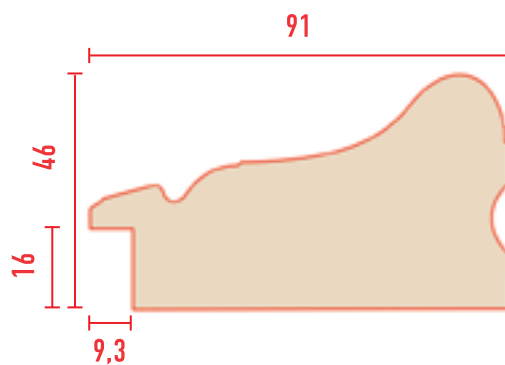



коллекция

РЕНЕССАНС



927-252

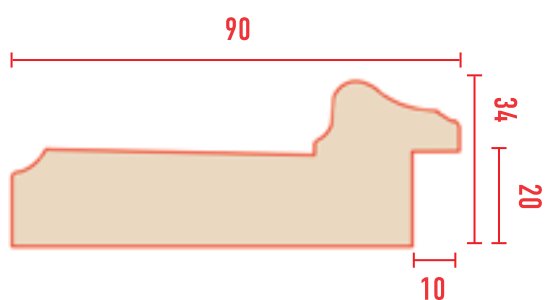



293-752

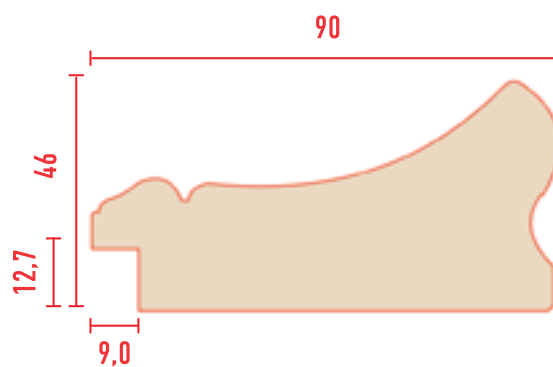



коллекция

РЕНЕССАНС



849-566

849-565

849-373

849-919

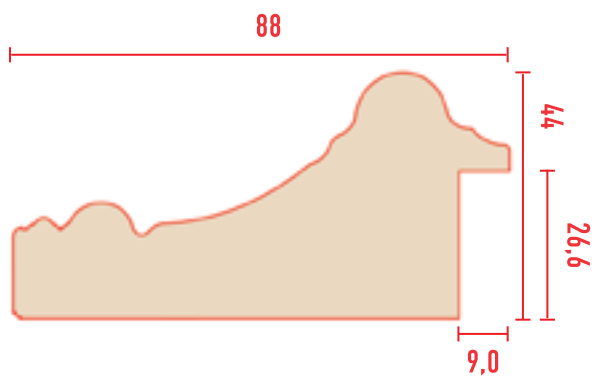



868-645

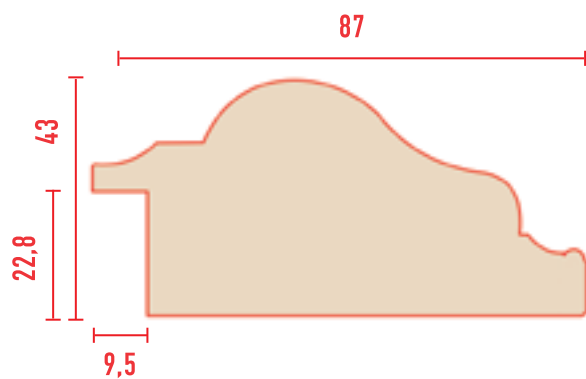



коллекция

РЕНЕССАНС



516-1069



516-1333

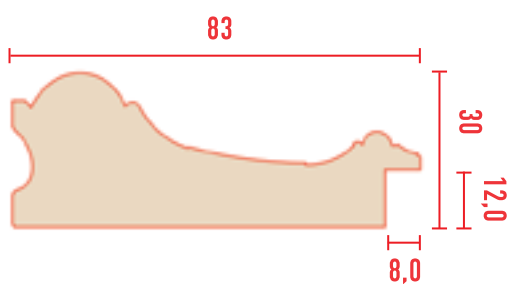



516-767



516-127



516-1070

516-126

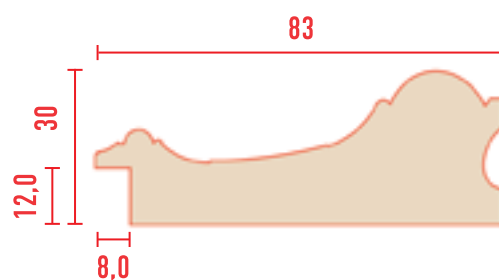



коллекция

РЕНЕССАНС

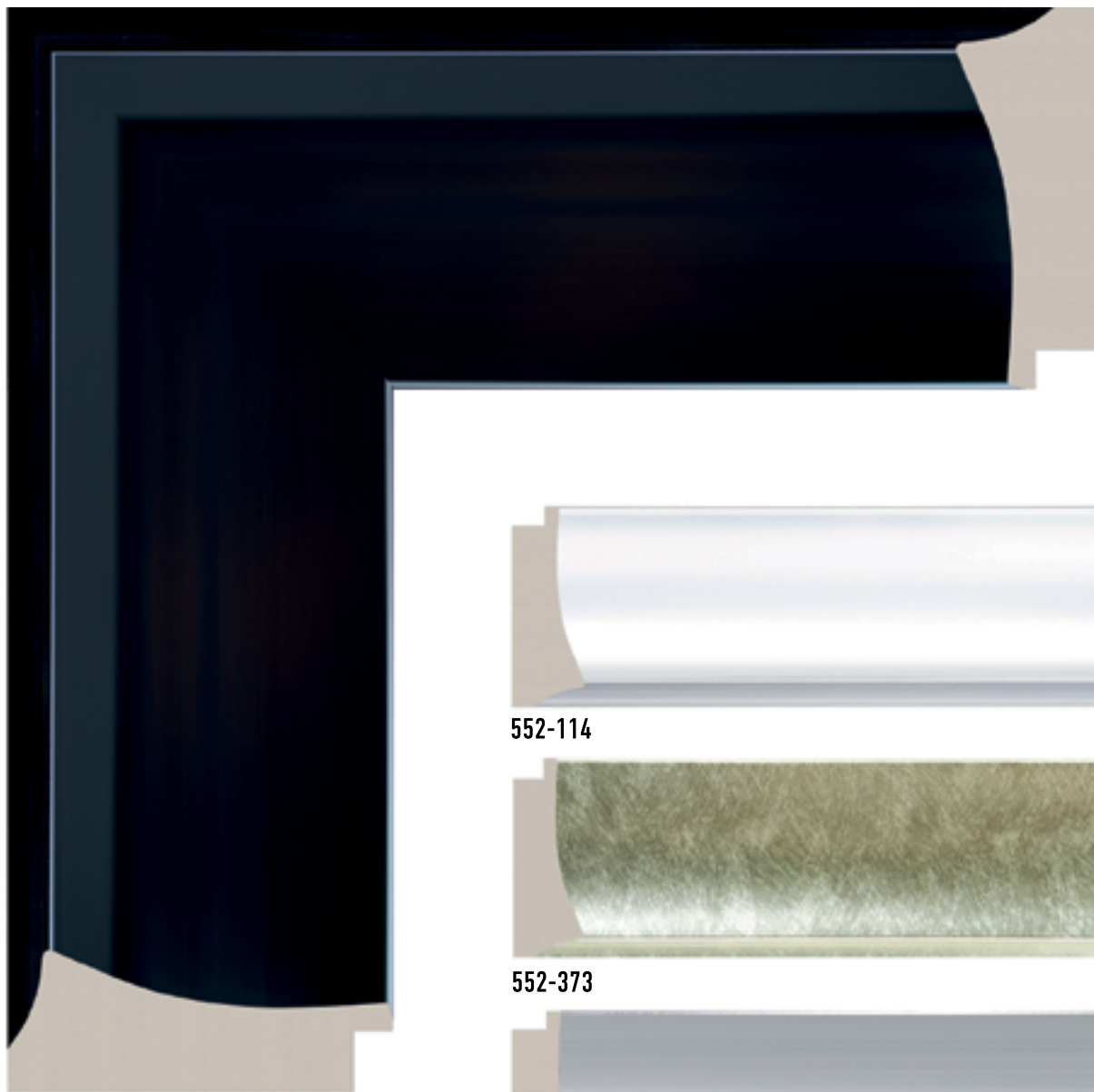

552-195



552-114

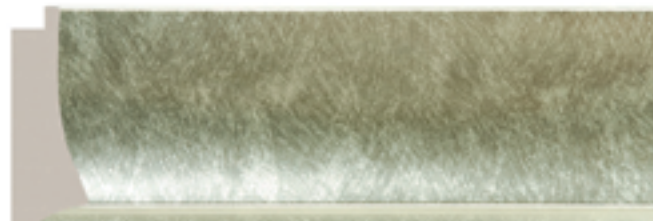

552-373



552-1153

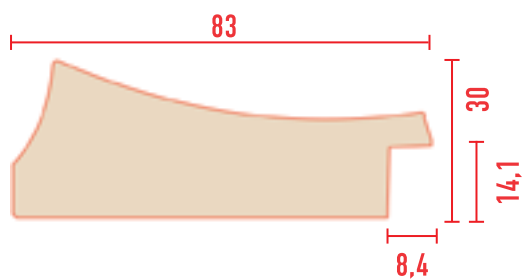



228-565



228-650

228-566

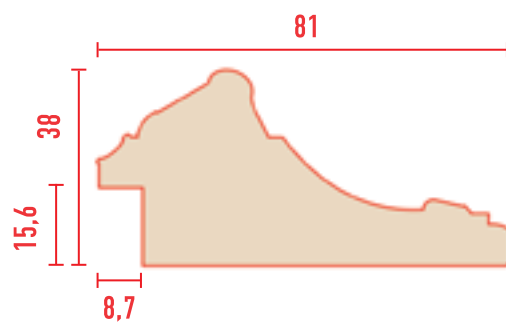



коллекция

РЕНЕССАНС



S18-966



S18-1223



S18-1224

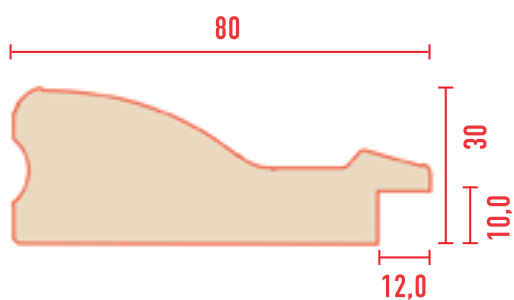



696-401



696-182

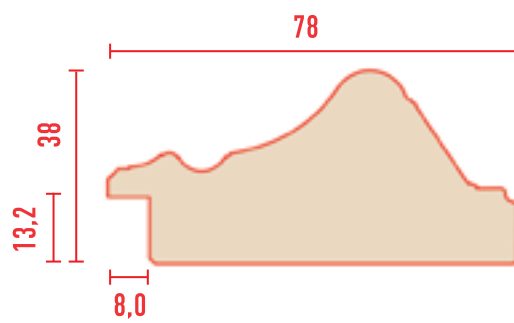

коллекция



РЕНЕССАНС

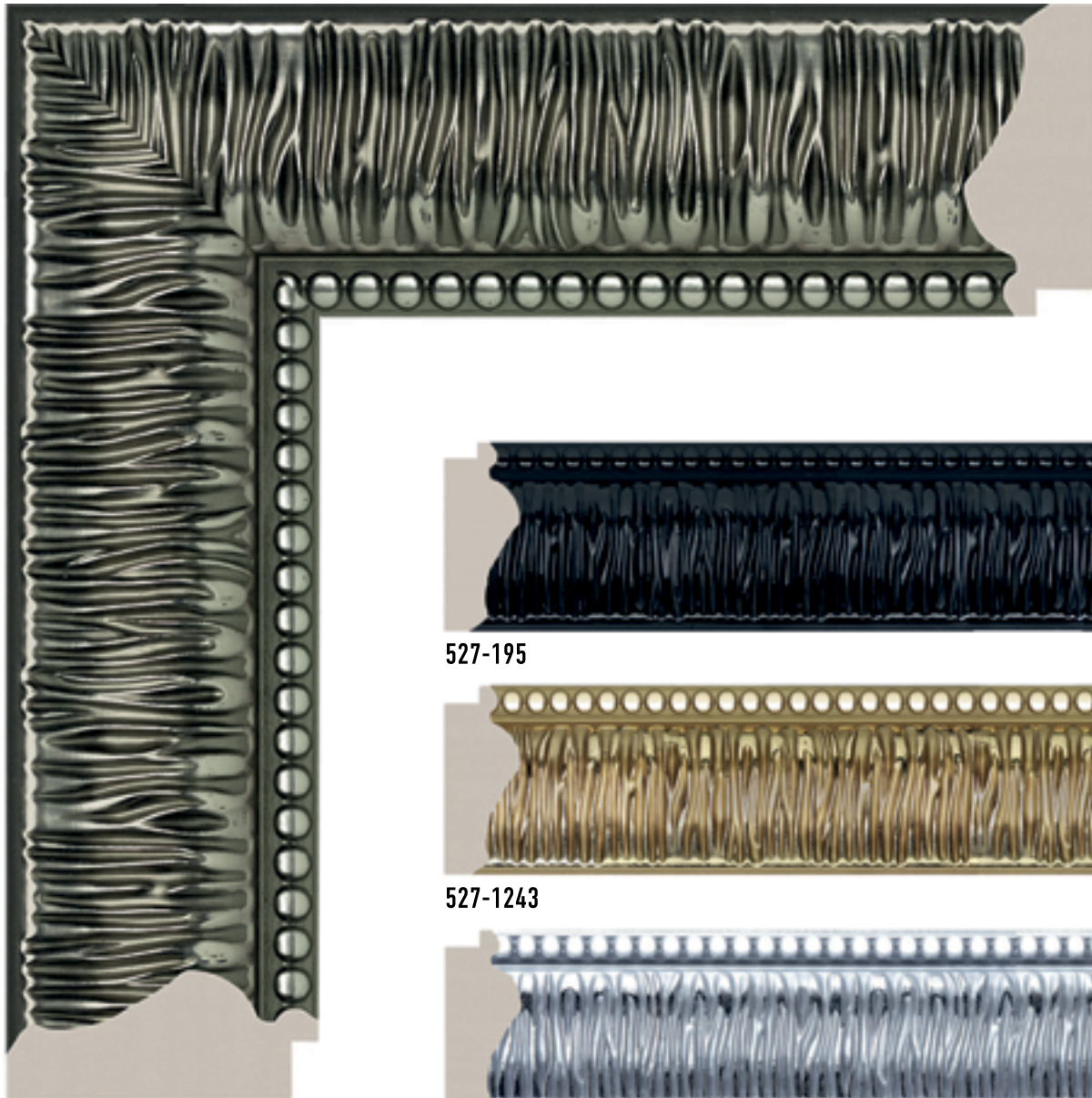

527-725



527-195



527-1243

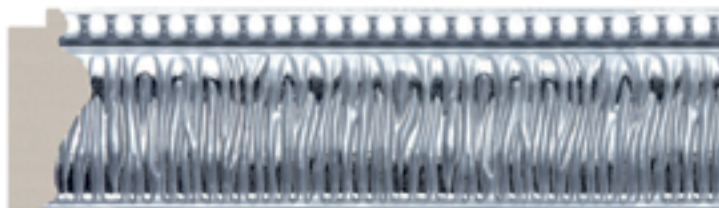

527-1244



527-114

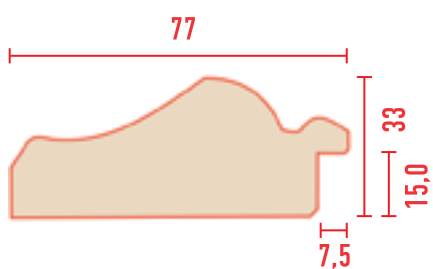



978-565



978-566

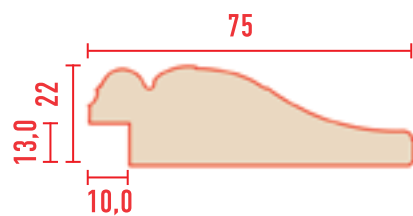



коллекция

РЕНЕССАНС



582-26



582-433



582-438



582-440



582-27

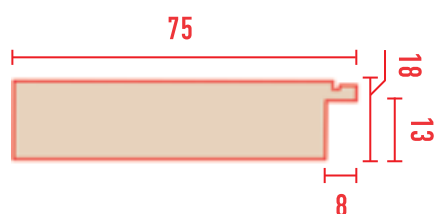

STANDARD

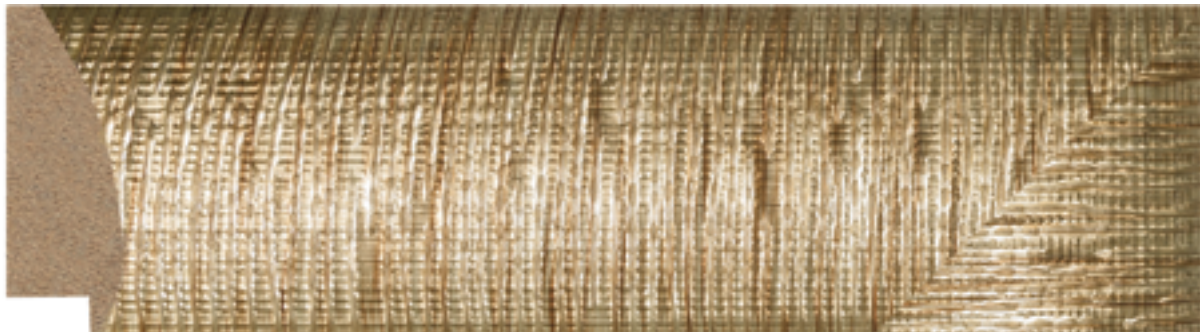

811M-905



811M-906

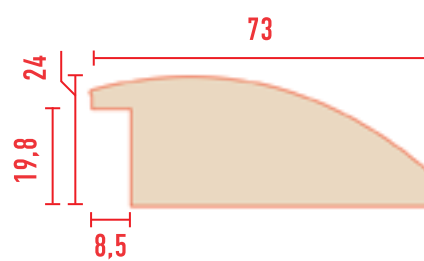

коллекция



РЕНЕССАНС



577-1223



577-966

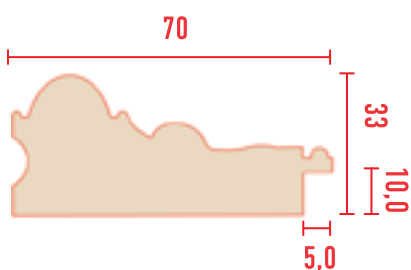



108-28



108-29



108-18



108-19



108-20



108-17

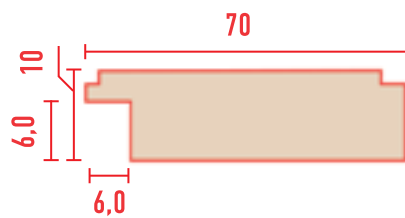



коллекция

РЕНЕССАНС



566-1223



566-1224

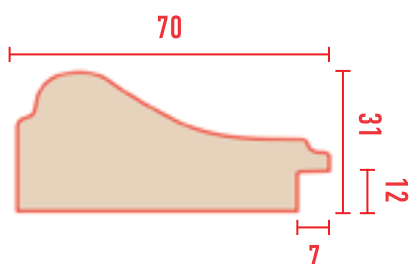



690-198

690-182

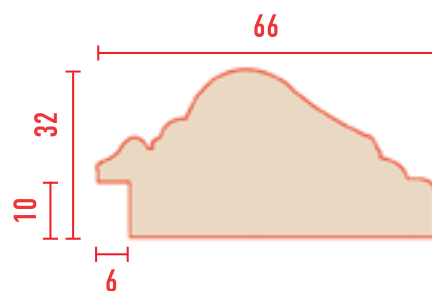



коллекция

РЕНЕССАНС



524-1070



524-1069



524-1333

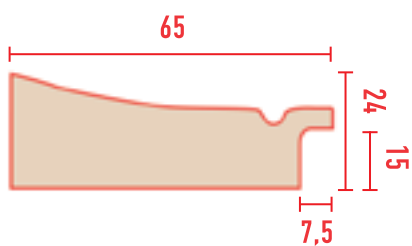



176-1



176-3



176-4



176-5



176-6

176-2

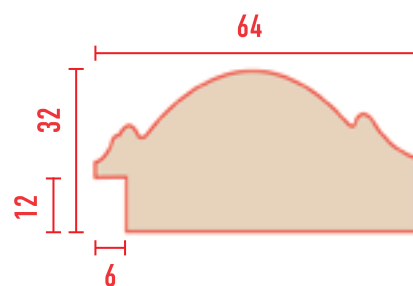



коллекция

РЕНЕССАНС



829-934



829-294



829-935

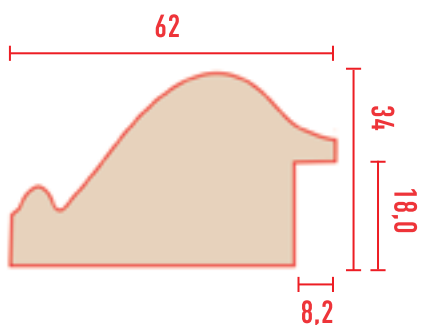



304 -566



304 -126



304 -127

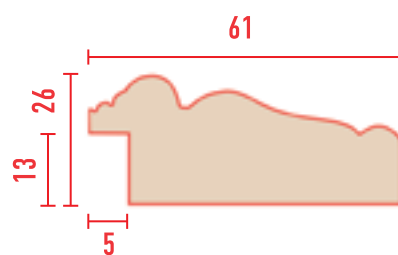



коллекция

РЕНЕССАНС



808-553



808-176N



808-552



808-176S

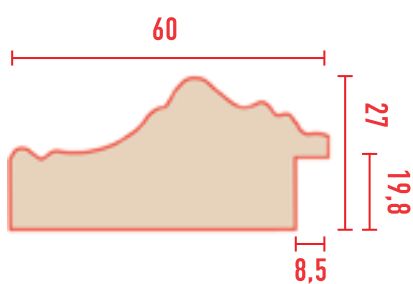



175-1



175-2



175-4



175-5



175-6

175-3

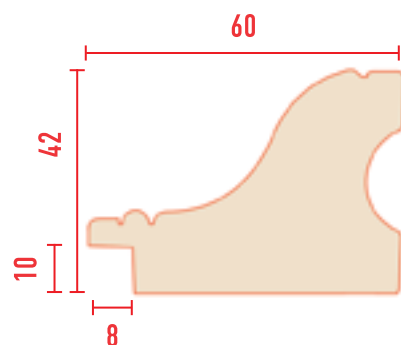

коллекция



РЕНЕССАНС



548M-440

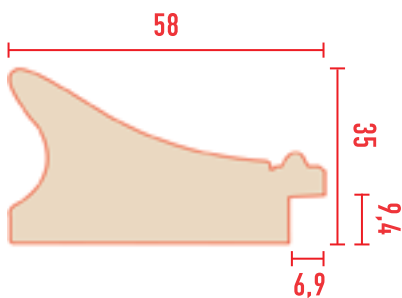



556-2



556-4



556-6

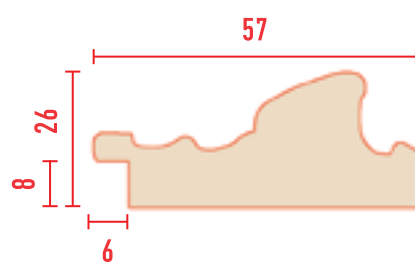



коллекция

РЕНЕССАНС

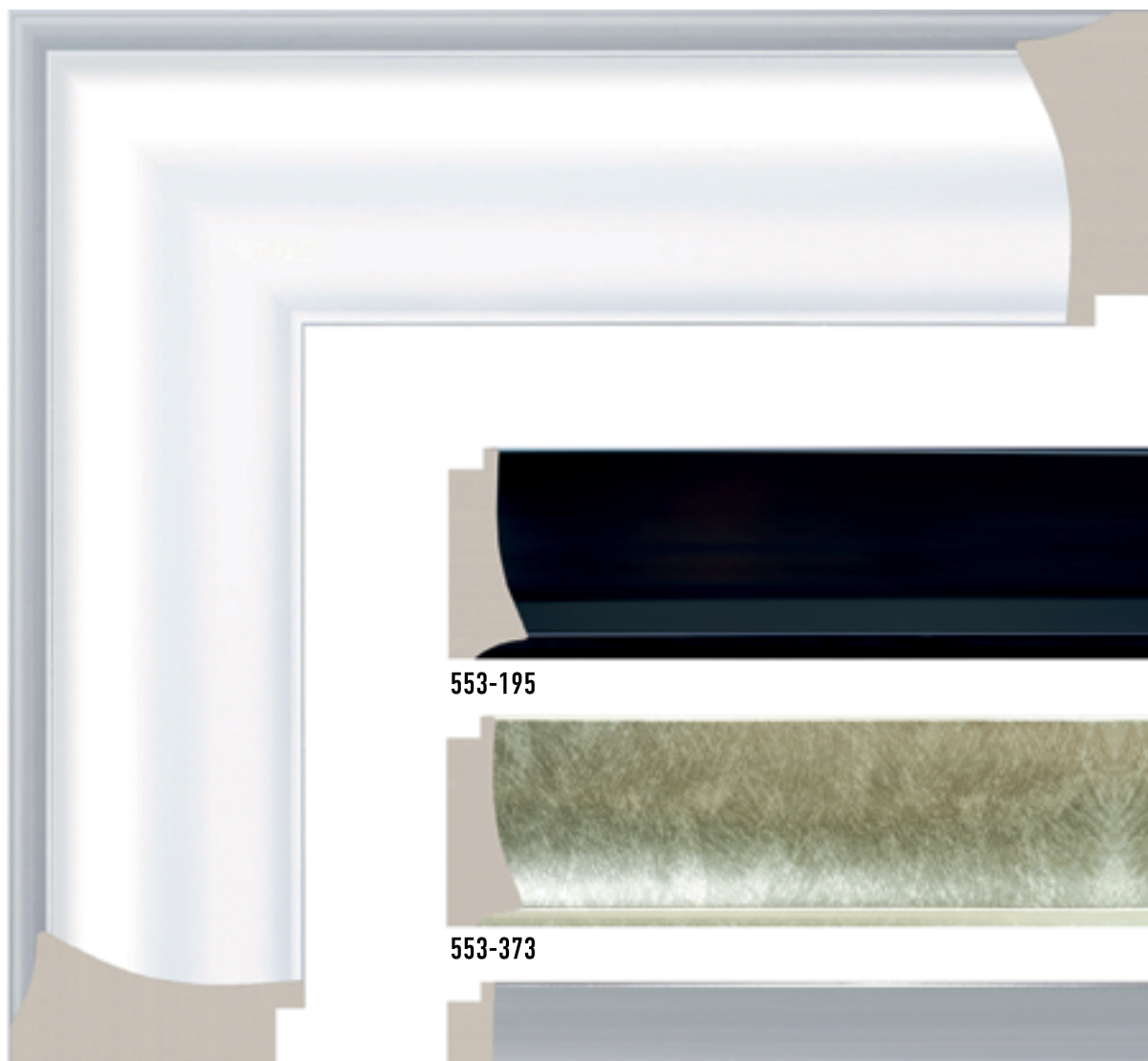

553-114



553-195



553-373



553-1153

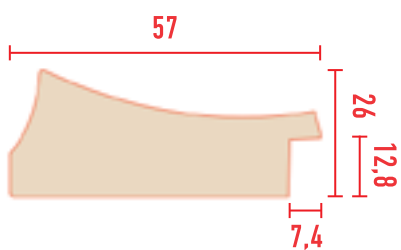

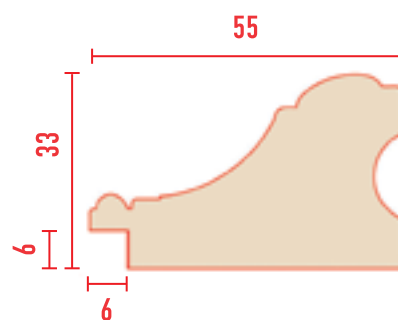
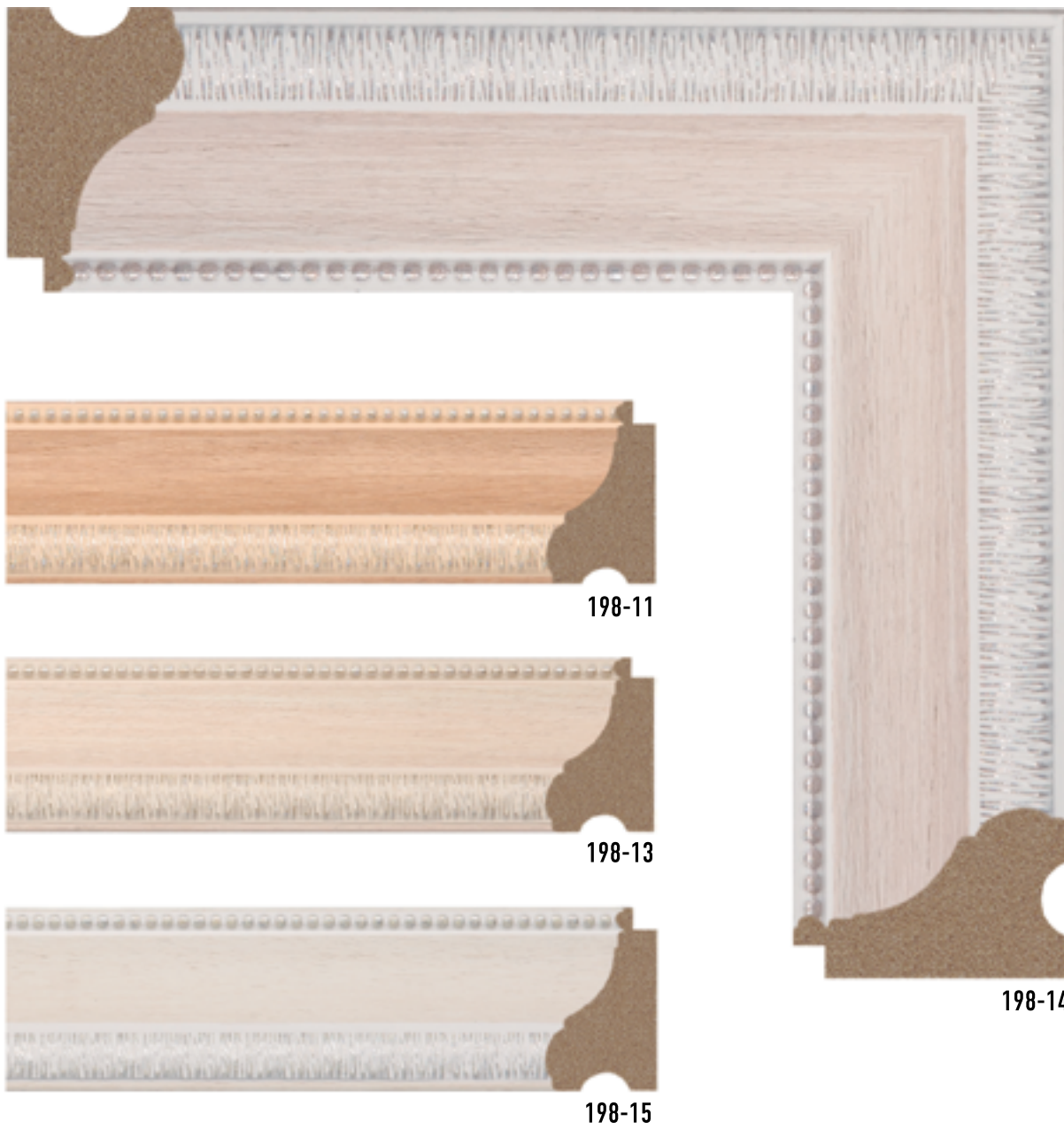



коллекция

РЕНЕССАНС



J11-966



J11-1223



J11-115



J11-1224

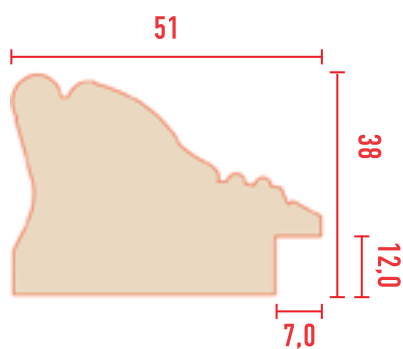



686M-566



686M-565

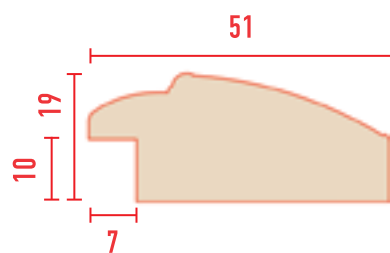



коллекция

РЕНЕССАНС



528-1243



528-195



528-1244



528-114

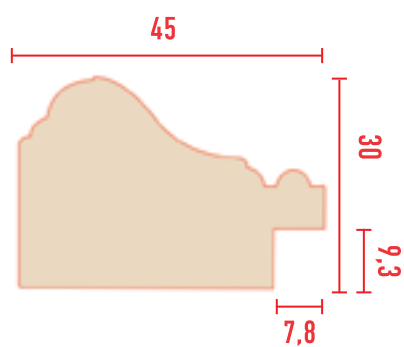



NEW J13-1223



NEW J13-1224



NEW J13-966

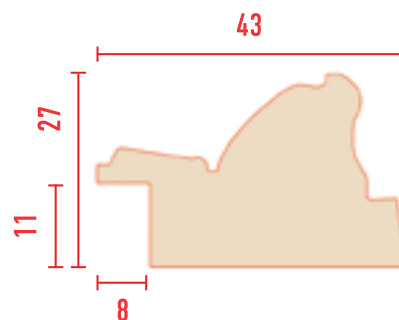



коллекция

РЕНЕССАНС

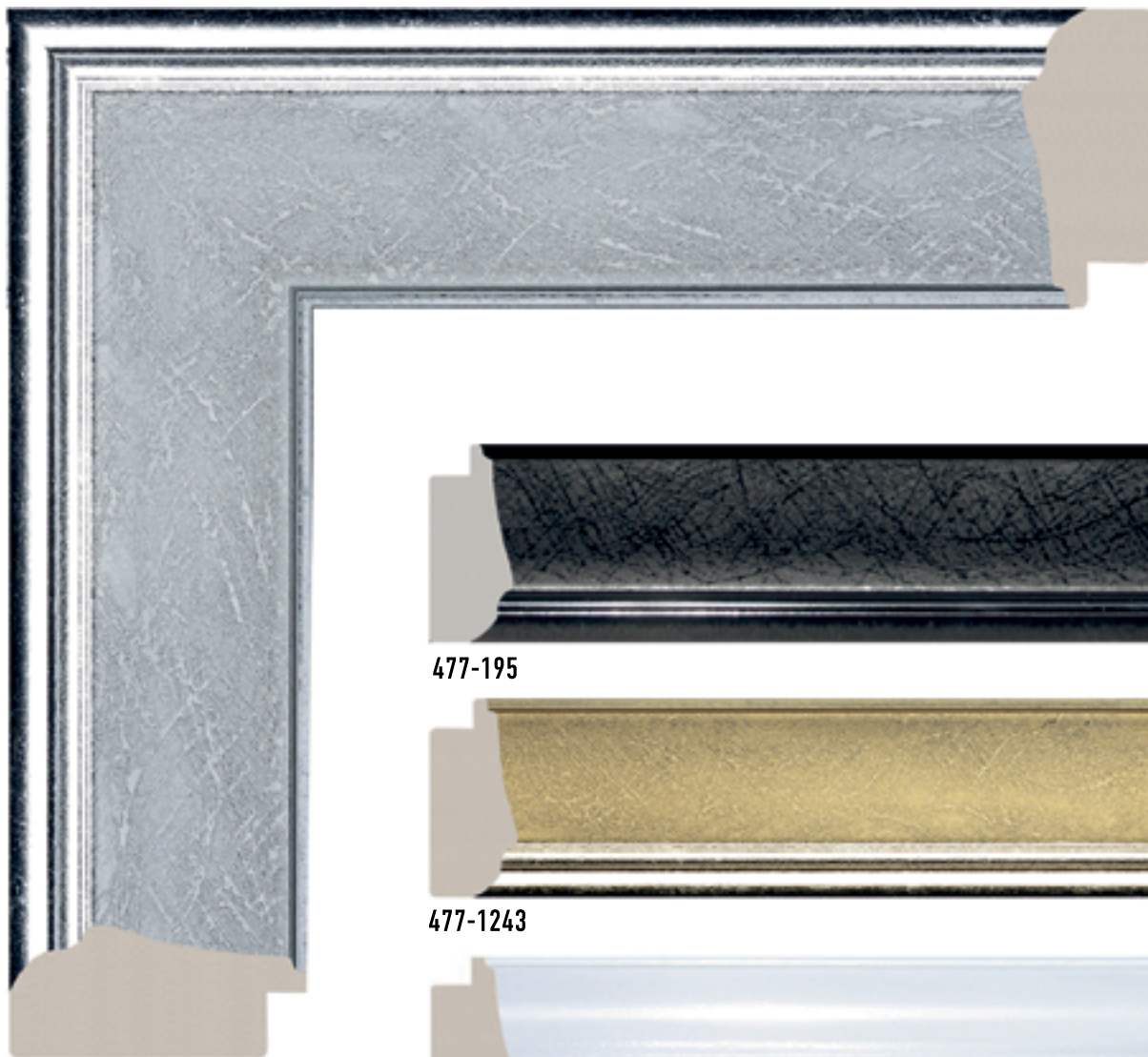

477-1244



477-195



477-1243



477-114

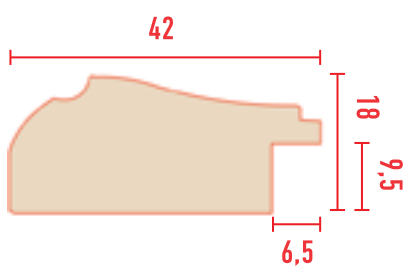

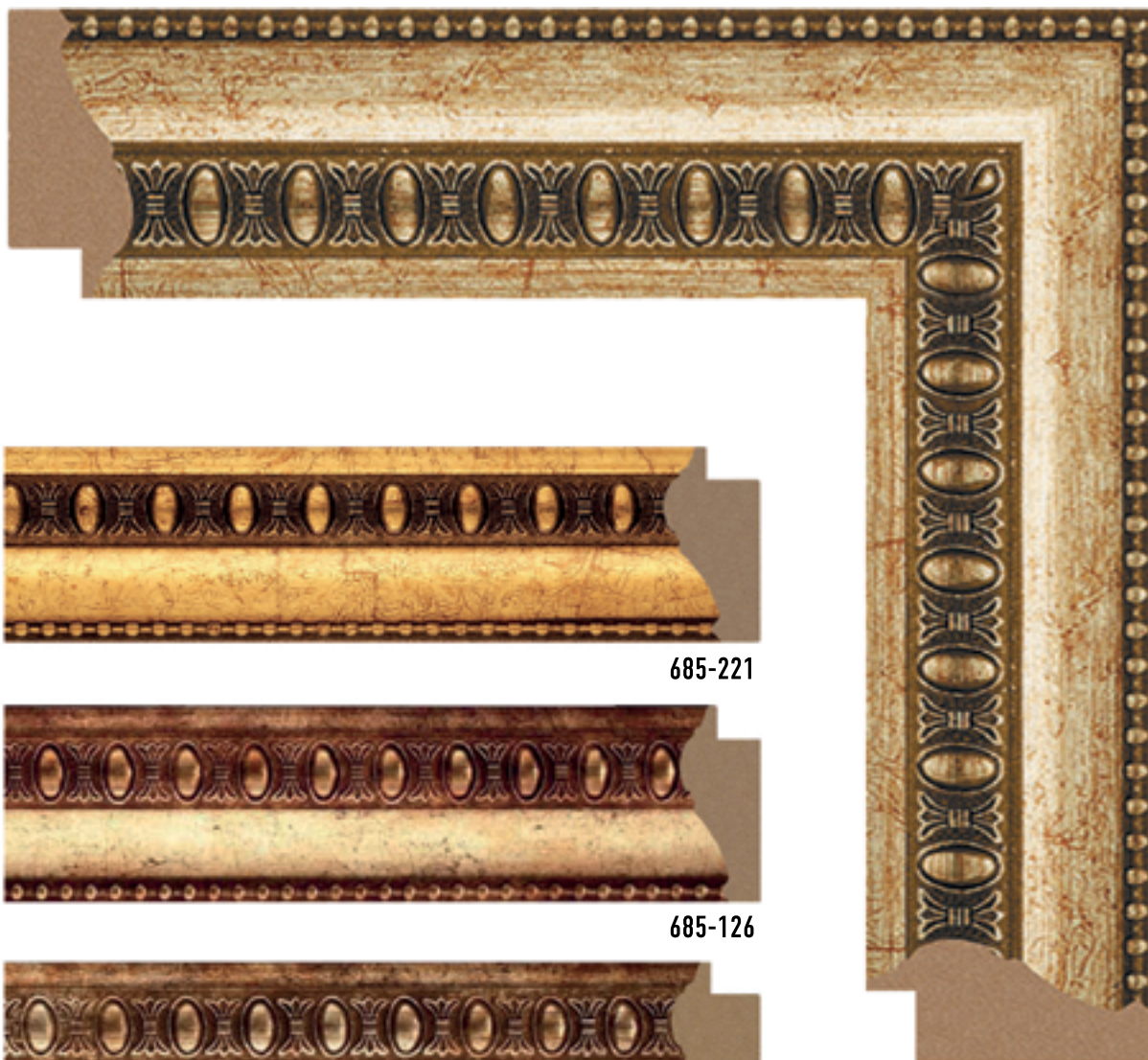

685-221



685-126



685-127



685-182

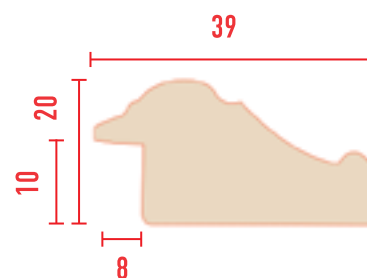



коллекция

РЕНЕССАНС



807-56

807-966

807-57

807-1223

807-58

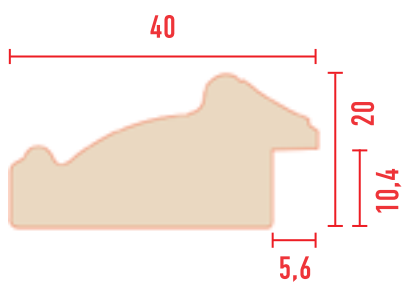

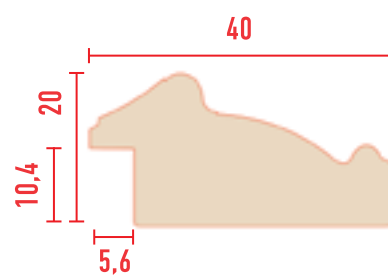



коллекция

РЕНЕССАНС



807-2

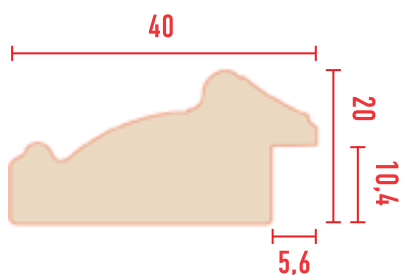

807-1



807-3



807-4



807-5



807-553



807-552



807-43

807-44

807-41

807-40

807-42

807-6

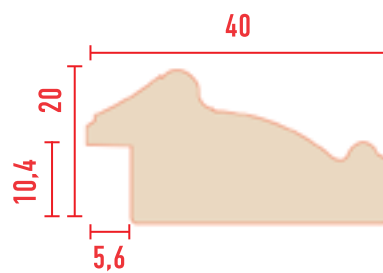



коллекция

РЕНЕССАНС



109-28



109-17



109-29



109-18



109-19



109-20

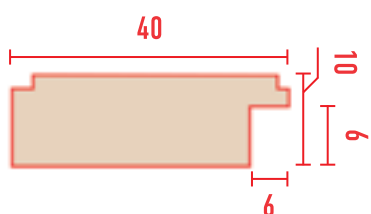

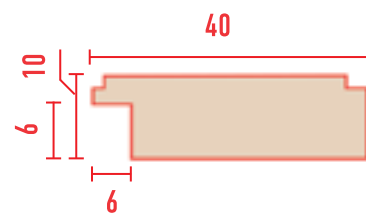
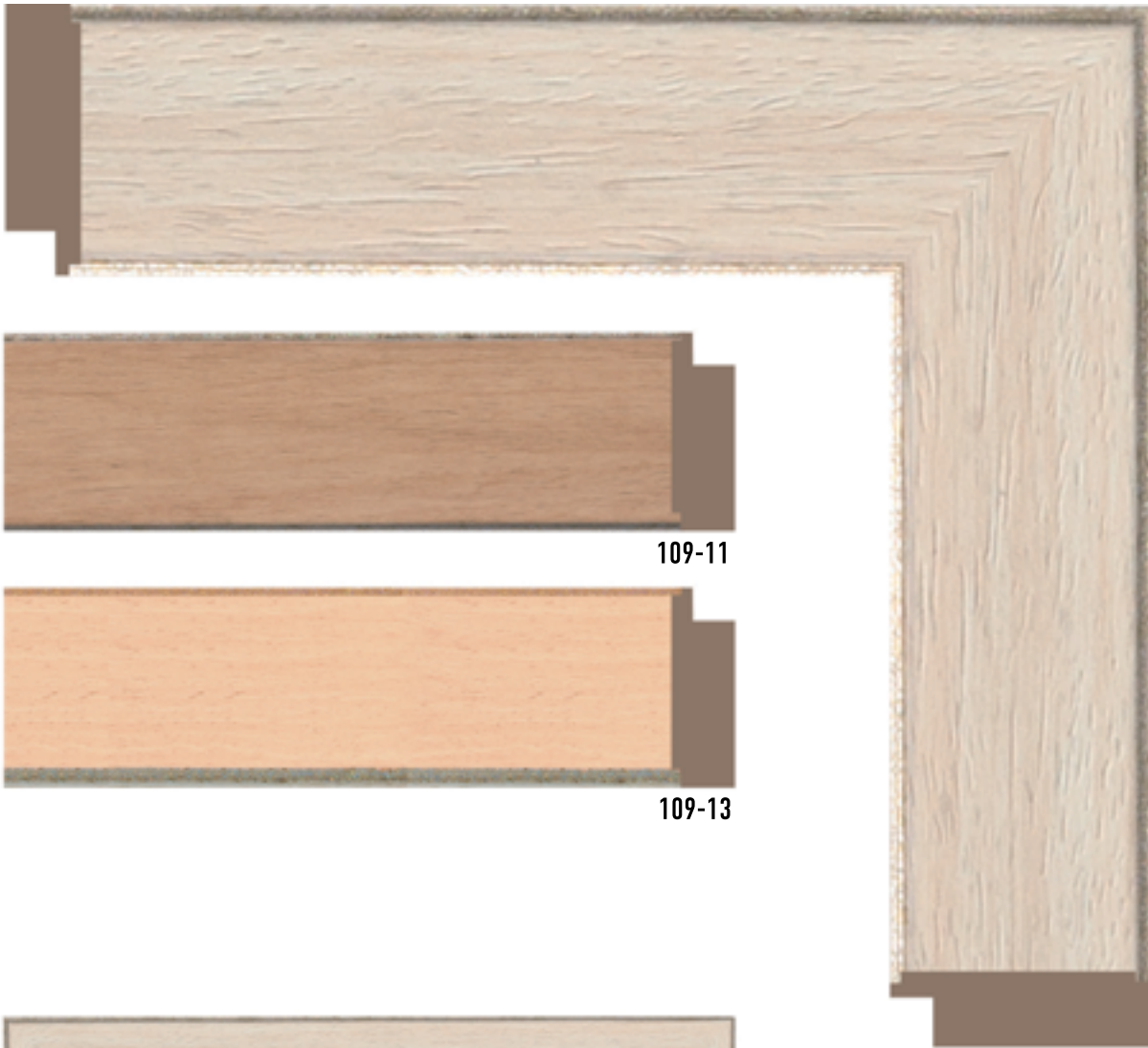



коллекция

РЕНЕССАНС

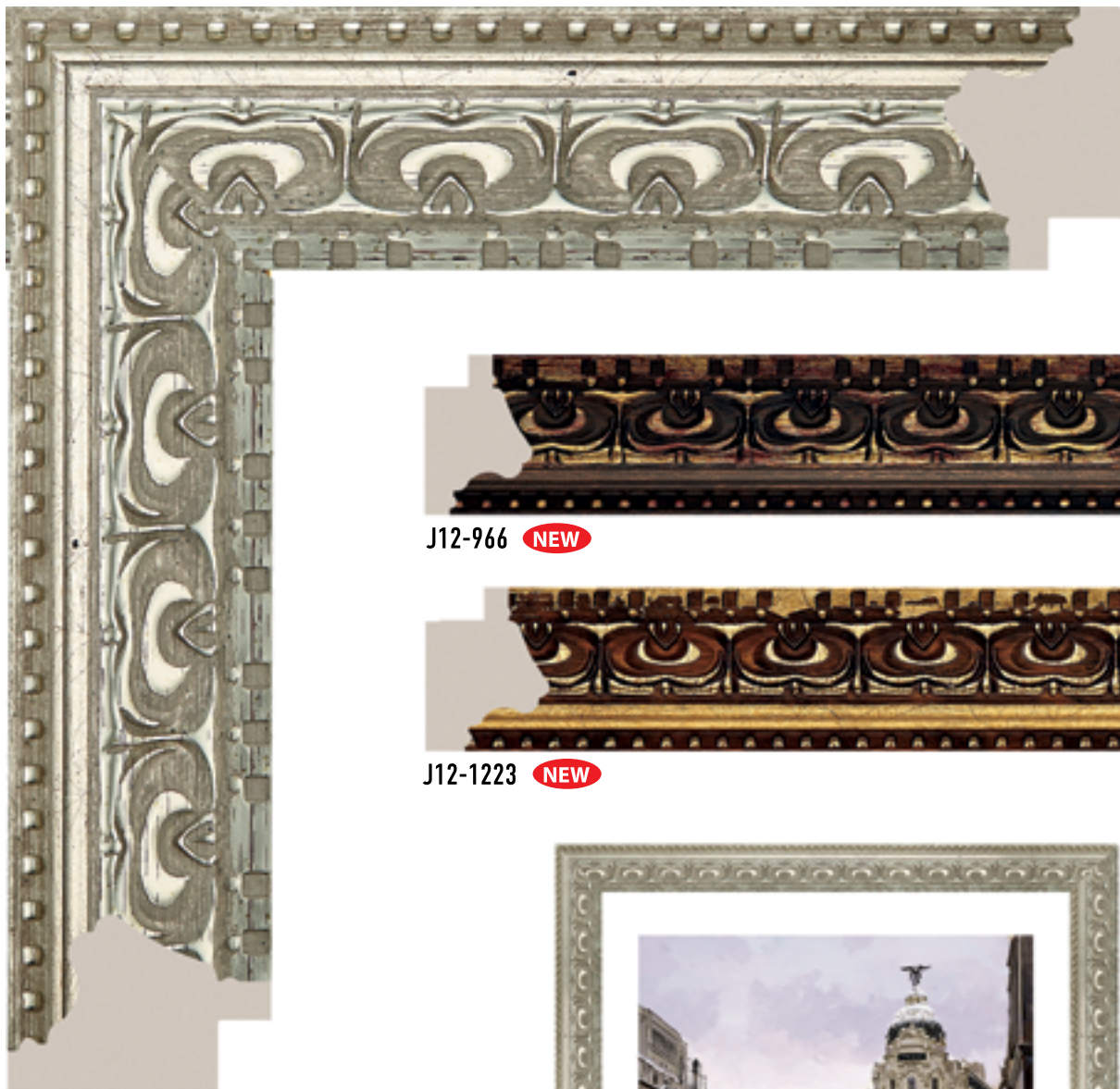

J12-1224 **NEW**



J12-966 **NEW**



J12-1223 **NEW**

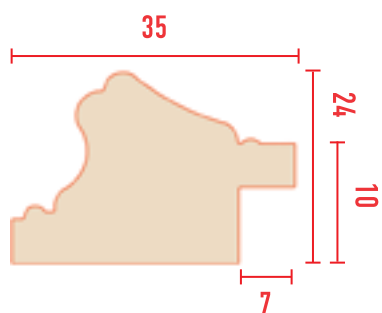



534-15



534-51



534-52



534-53



534-11



534-13



534-14

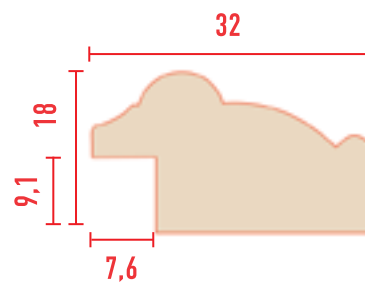



коллекция

РЕНЕССАНС



651-176s

651-176

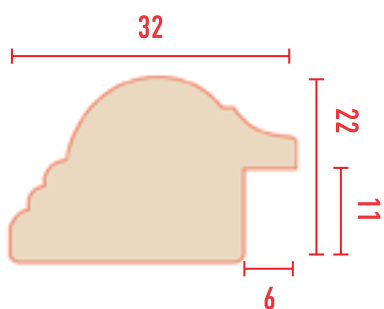



564-277



564-280

564-278

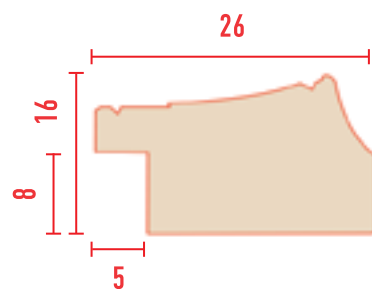

коллекция



РЕНЕССАНС



584-1070

584-1069

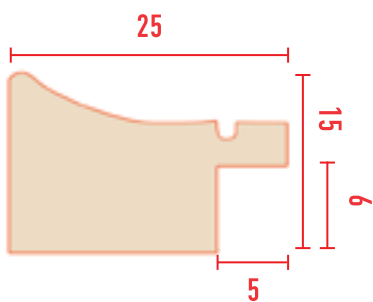

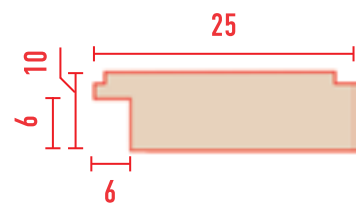



коллекция

РЕНЕССАНС



102-28



102-51



102-52



102-17



102-53



102-29

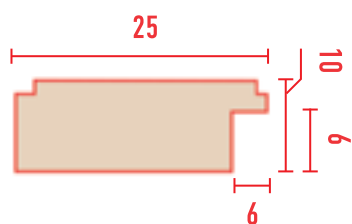

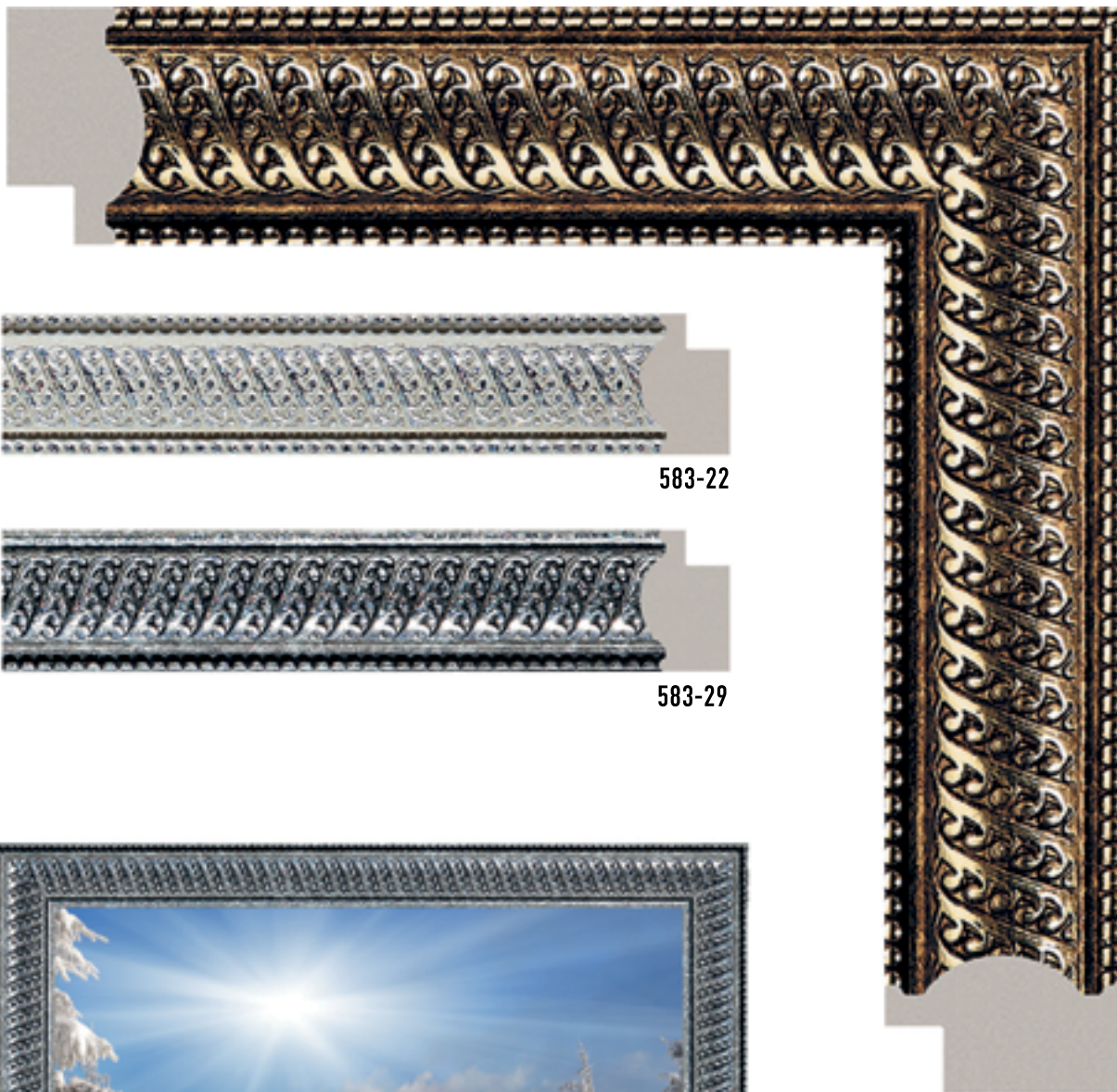

583-22



583-29



583-28

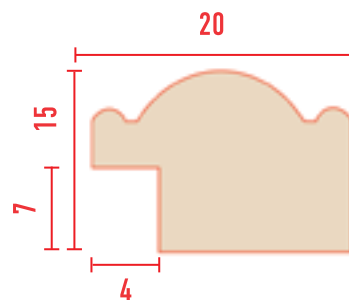



коллекция

РЕНЕССАНС



158-1



158-3



158-4



158-5



158-6



158-7D **NEW**



158-937



158-933



158-55



158-767

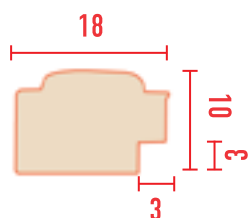



158-1084



158-553



158-54



158-115



158-118



158-127



158-126



158-281



158-1028



158-552

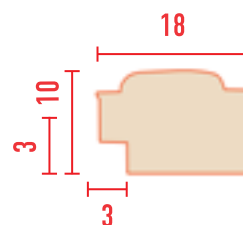



коллекция

РЕНЕССАНС



158-44

158-40

158-41

158-42

158-43

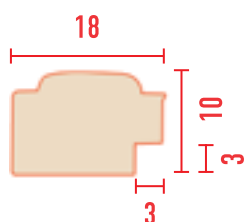

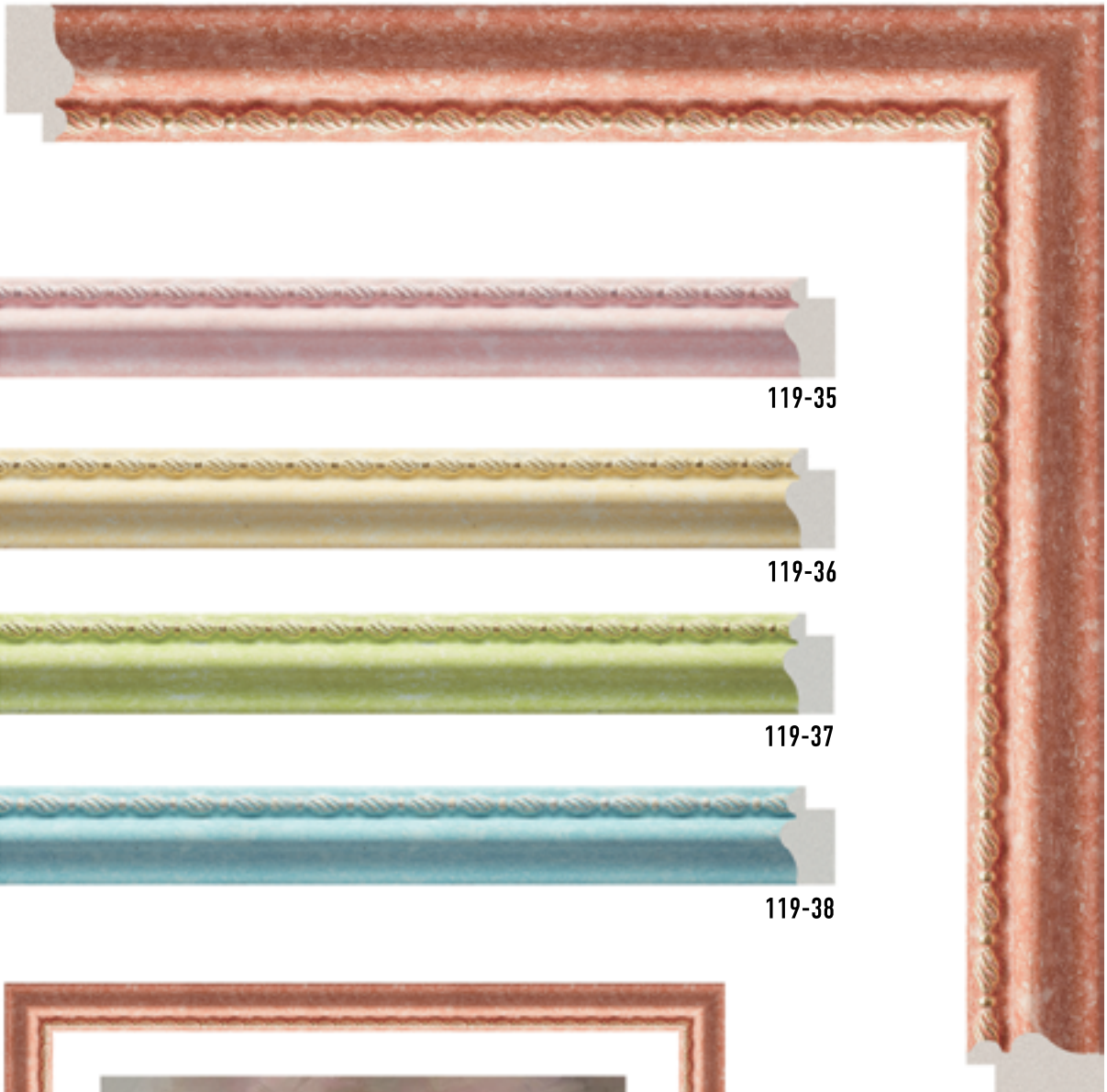

119-35



119-36



119-37



119-38



119-34

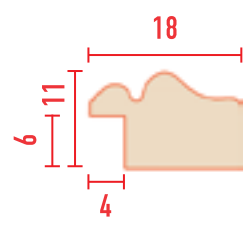



коллекция

РЕНЕССАНС



149-955

149-956

149-954

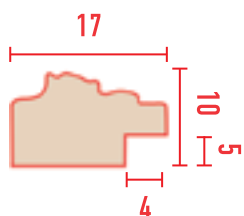



117-438

117-553

117-552

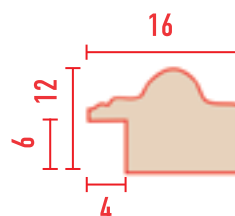



коллекция

РЕНЕССАНС



159B-565

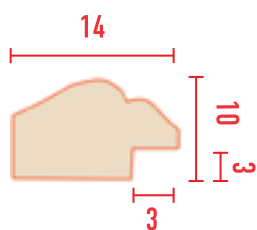



159D-553



159D-552

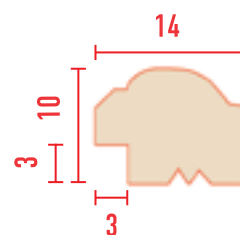

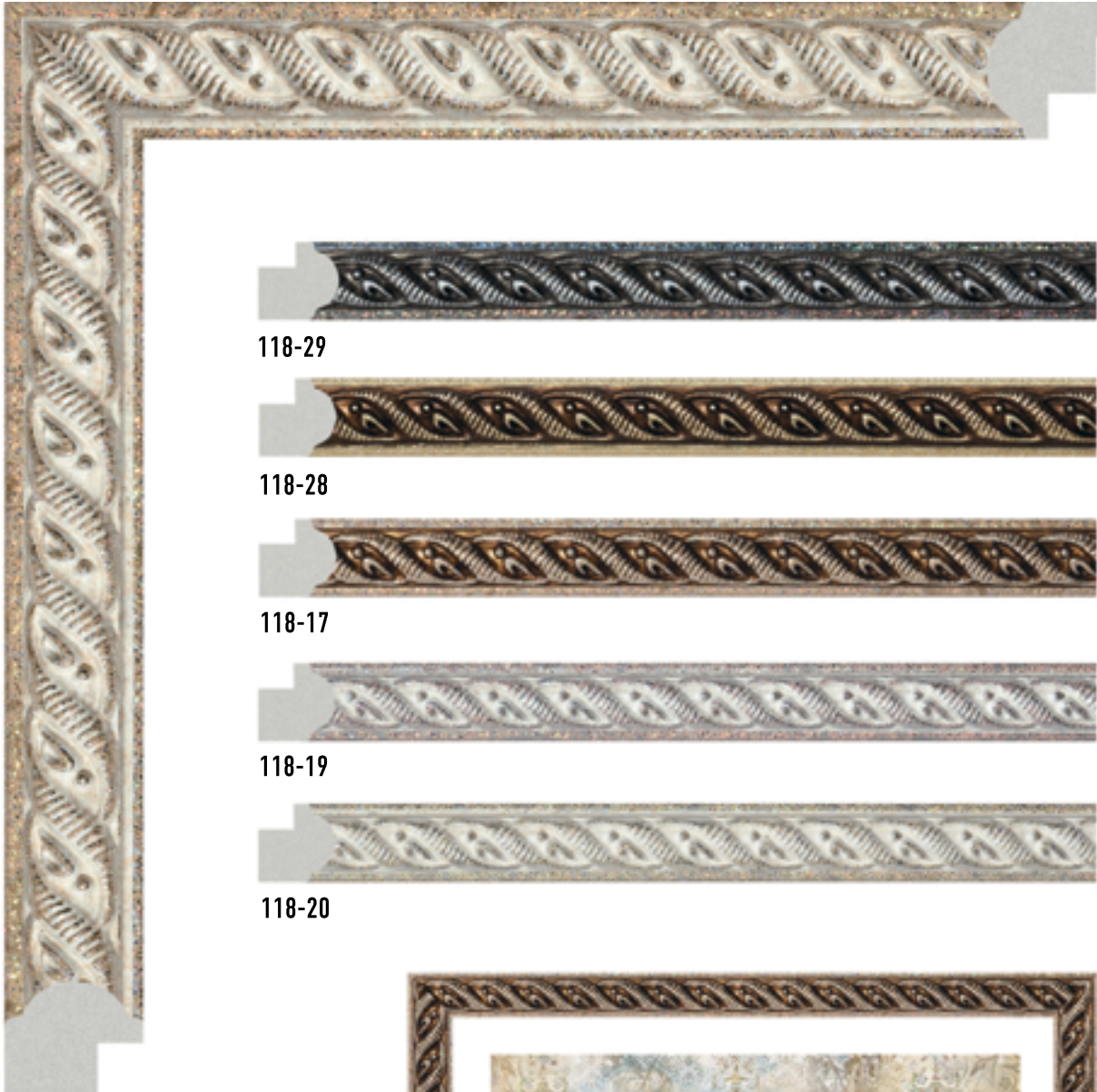

118-18

118-29

118-28

118-17

118-19

118-20

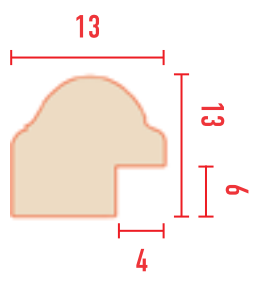



коллекция

ЭКЛЕКТИКА



FM22-1



FM22-3



FM22-4

FM22-2

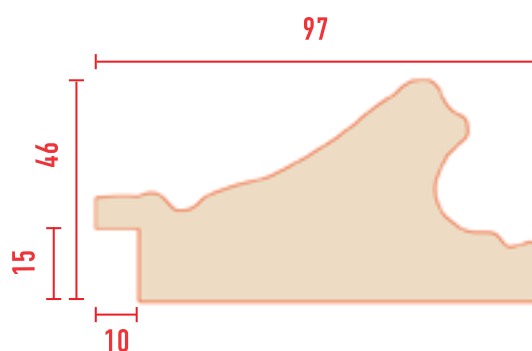



коллекция

ЭКЛЕКТИКА



FM9-2



FM9-1



FM9-3



FM9-4



FM9-5

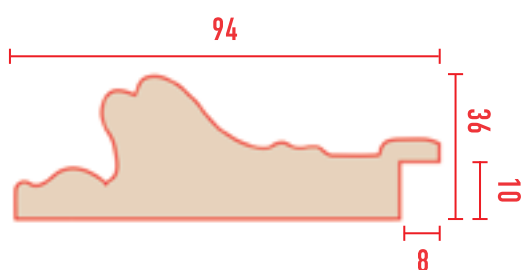



FM8-1

FM8-2

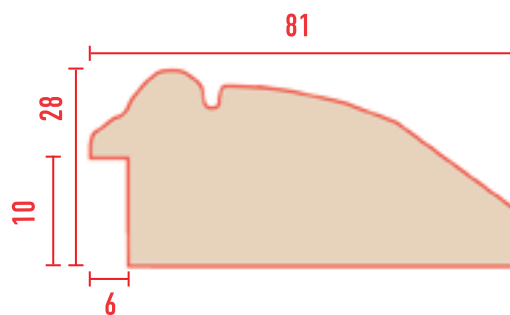



коллекция

ЭКЛЕКТИКА



FM4-2

FM4-3

FM4-1

FM4-4

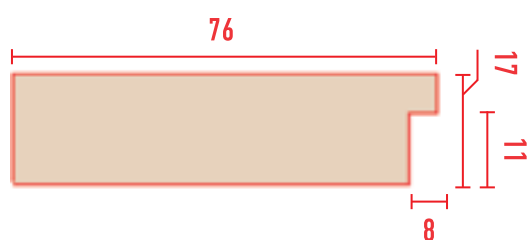



FM11-2

FM11-1

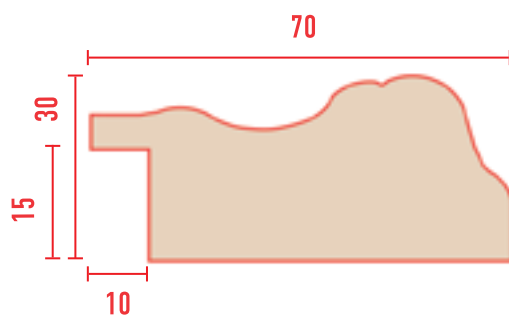



коллекция

ЭКЛЕКТИКА



FM14-1

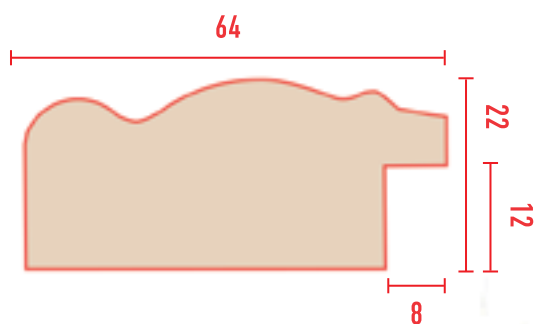



FM21-1



FM21-2

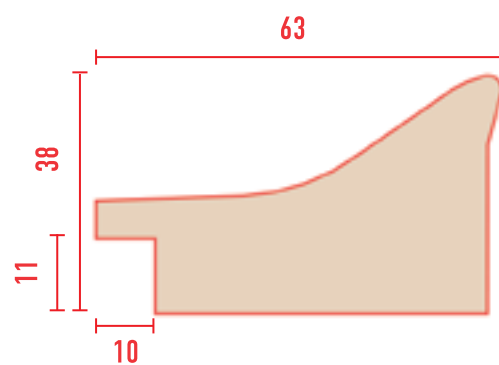



коллекция

ЭКЛЕКТИКА



FM10-3

FM10-2

FM10-1

FM10-4

FM10-5

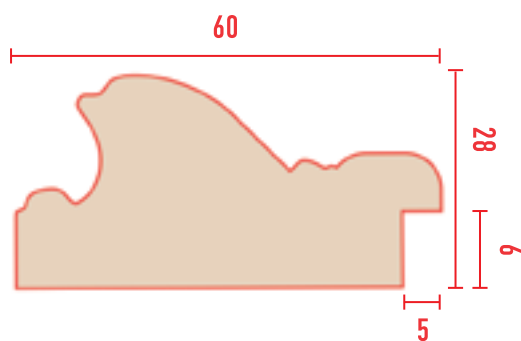



FM19-2



FM19-1

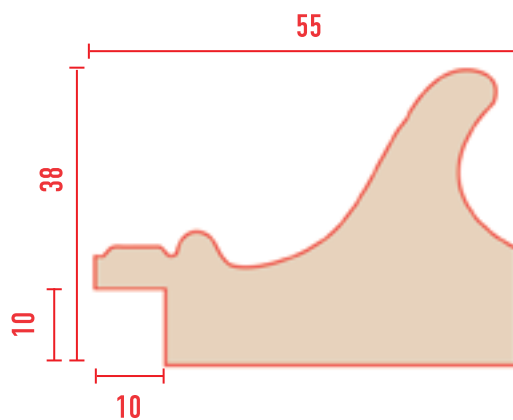



коллекция

ЭКЛЕКТИКА

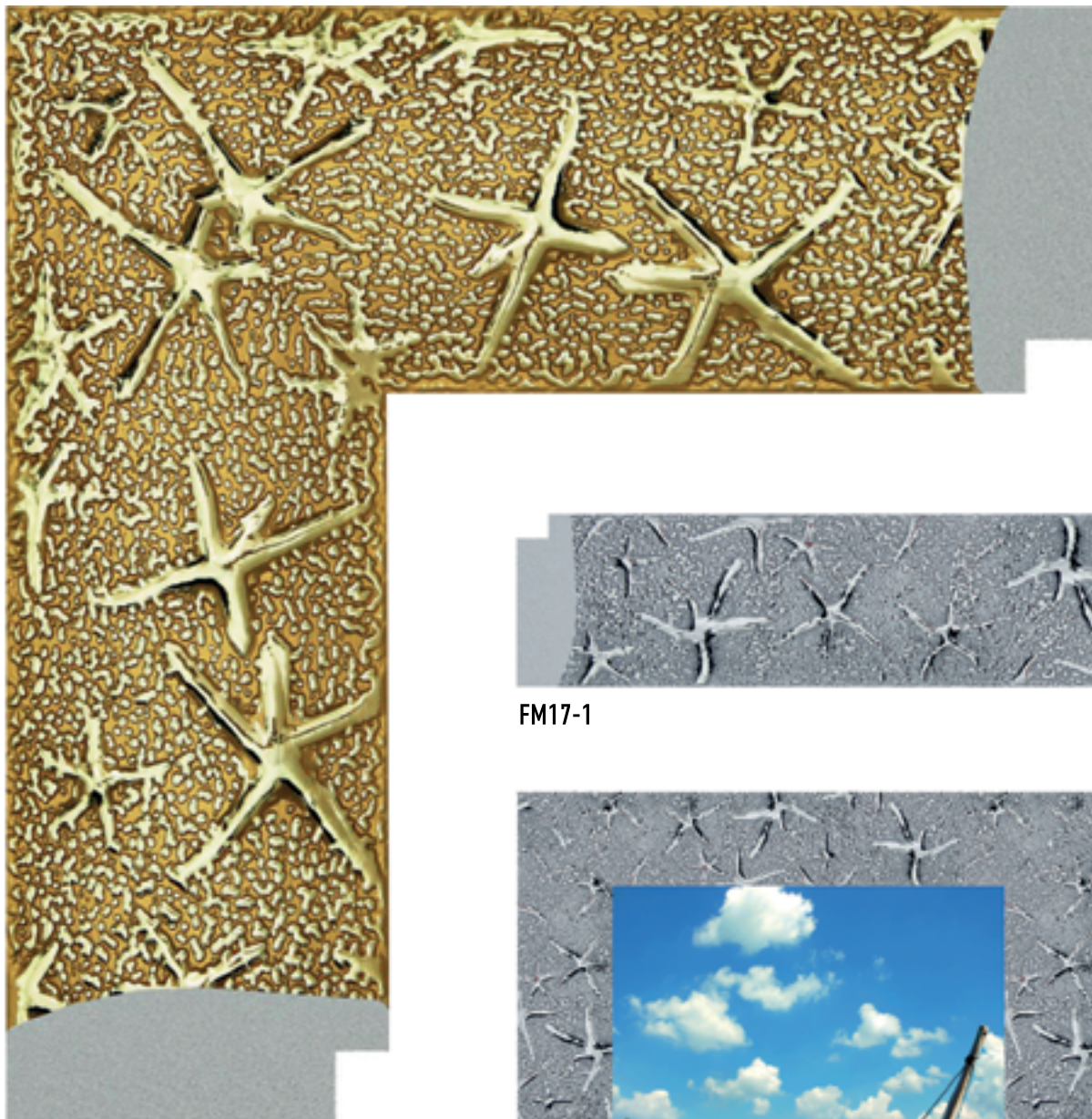

FM17-2

FM17-1

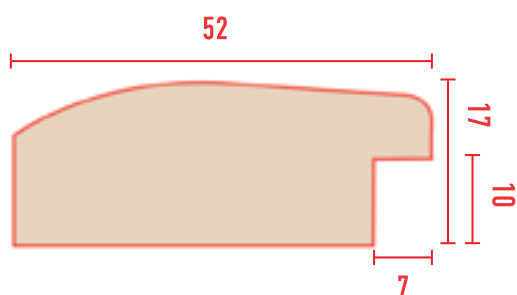



FM15-2

FM15-1

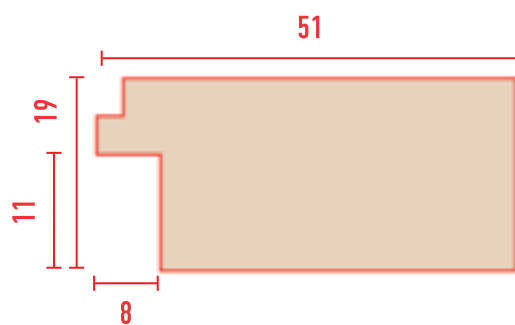



коллекция

ЭКЛЕКТИКА

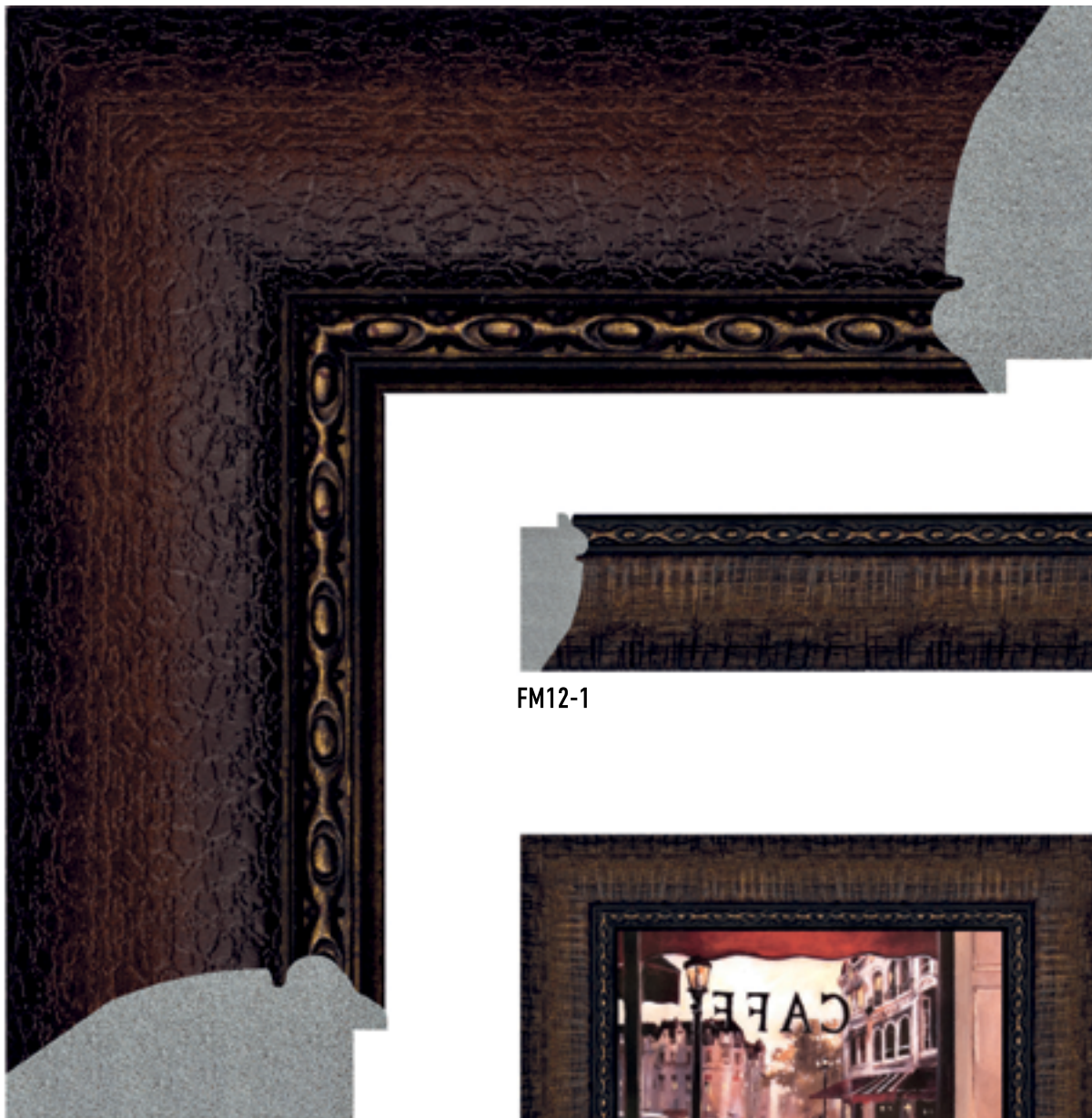

FM12-2



FM12-1

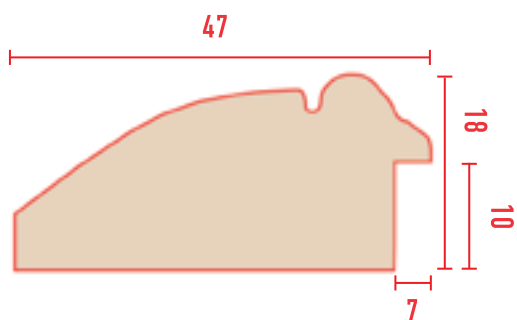

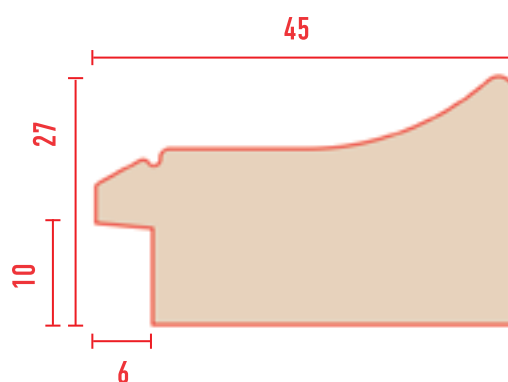
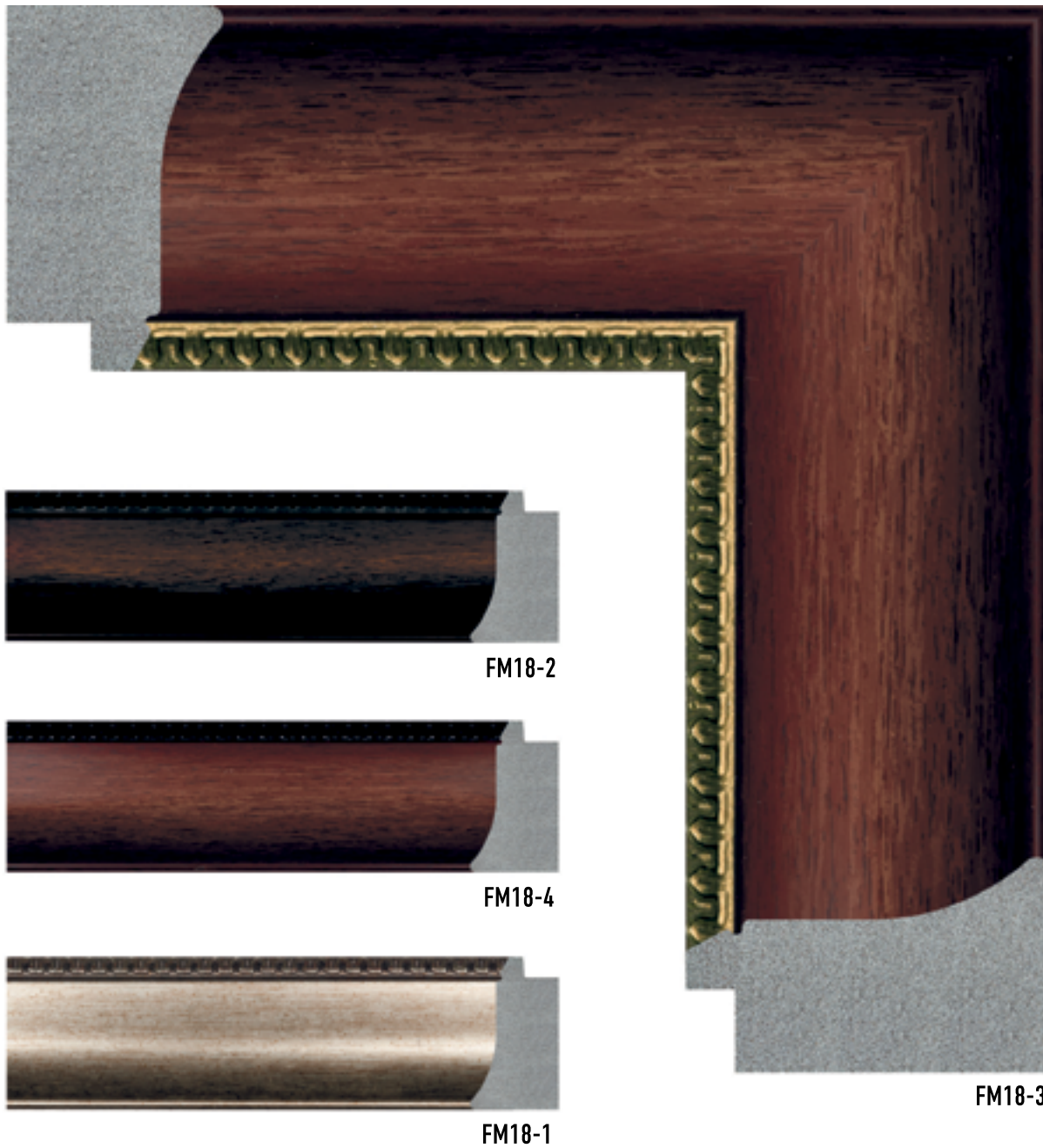



коллекция

ЭКЛЕКТИКА

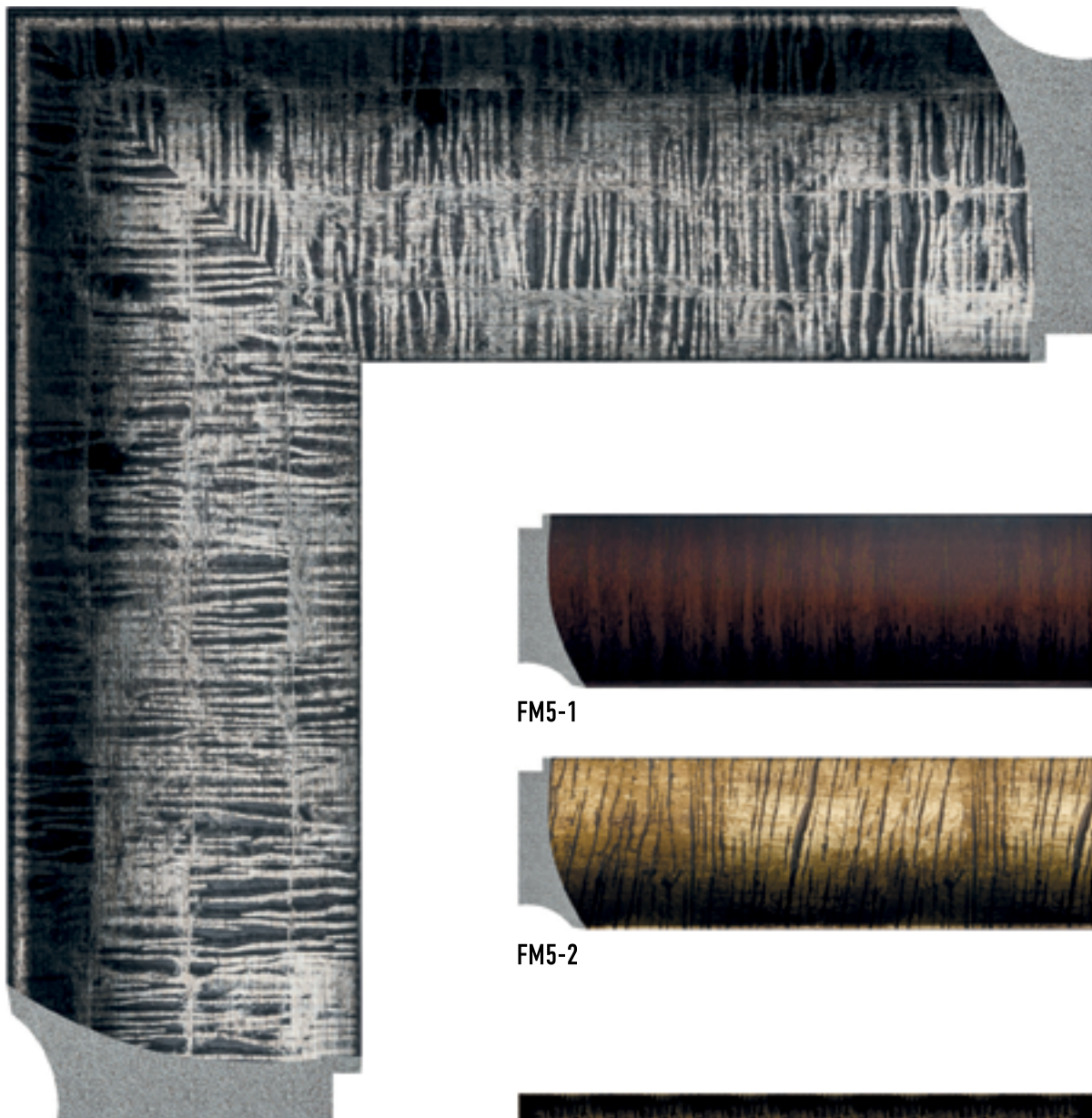

FM5-3



FM5-1



FM5-2

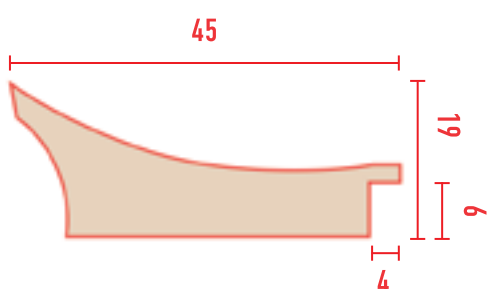



FM6-2

FM6-1

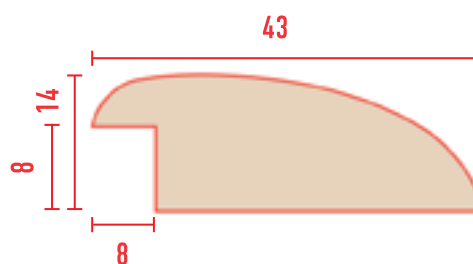



коллекция

ЭКЛЕКТИКА

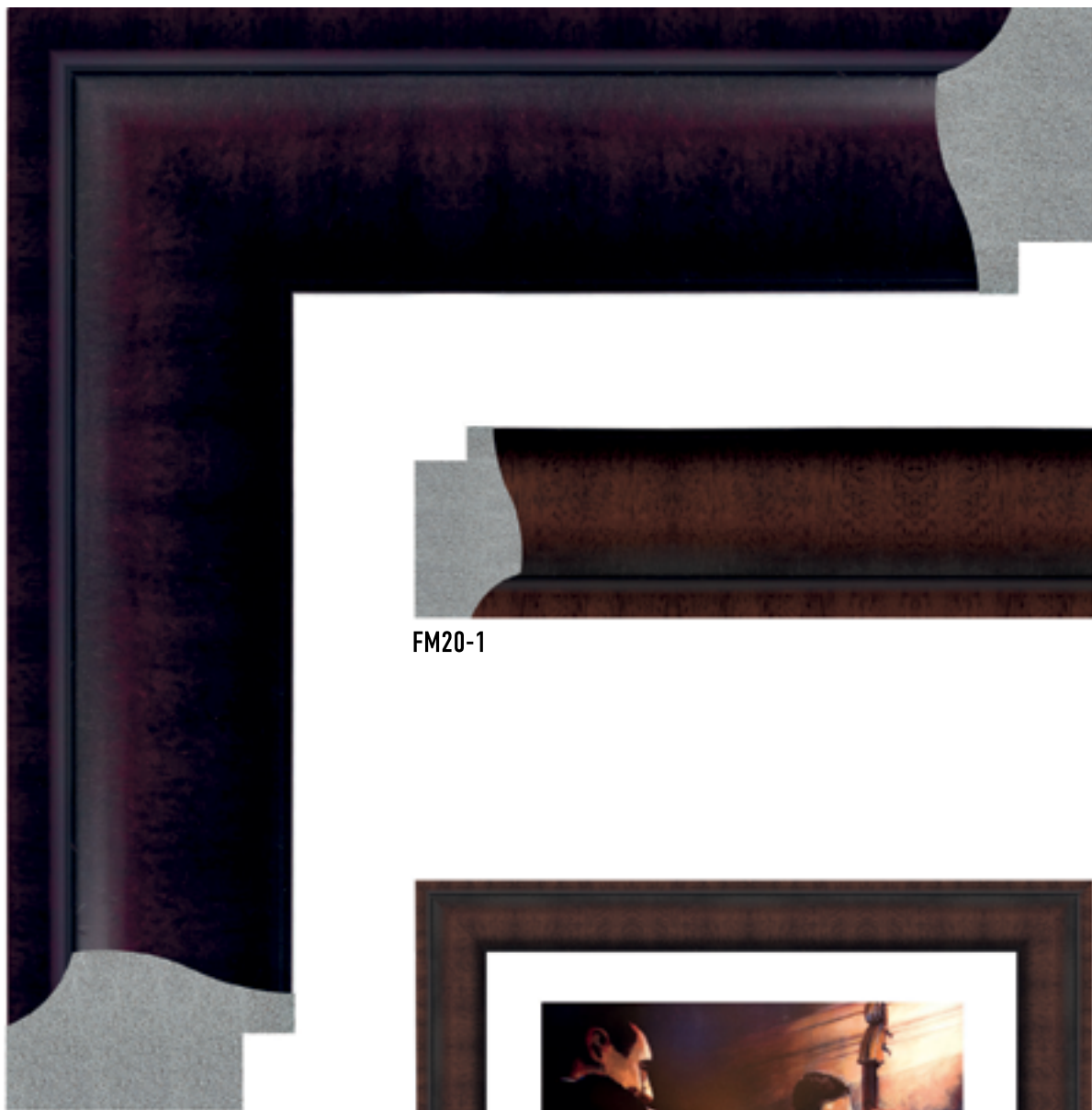

FM20-1

FM20-2

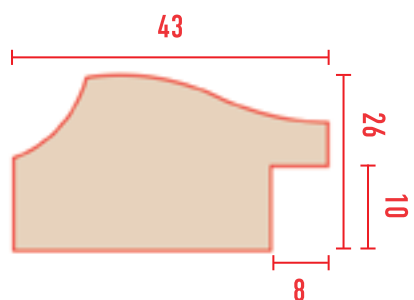

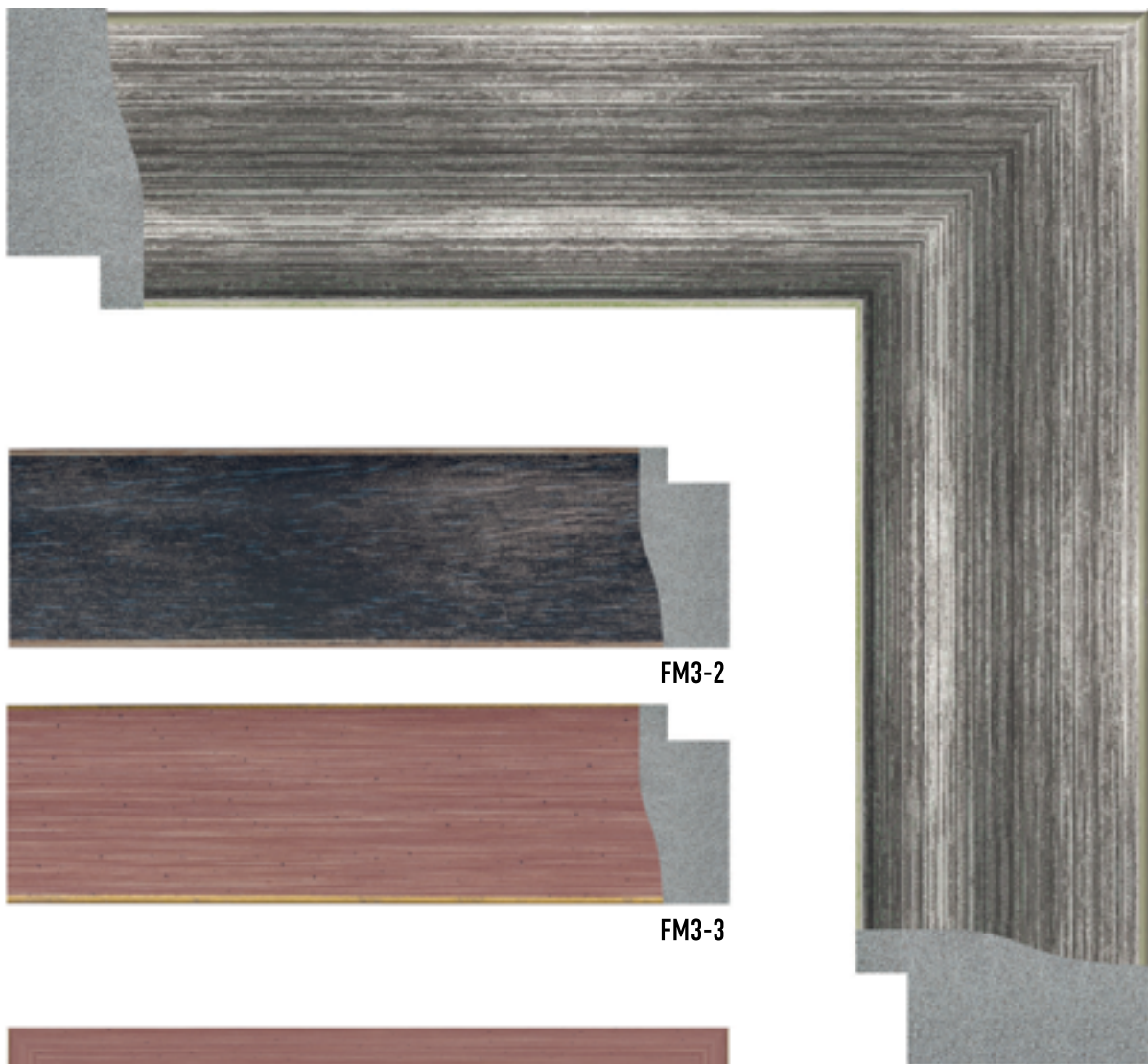

FM3-2



FM3-3



FM3-1

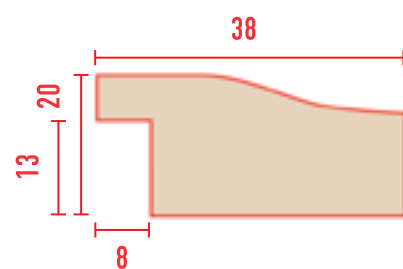



коллекция

ЭКЛЕКТИКА



FM16-1

FM16-2

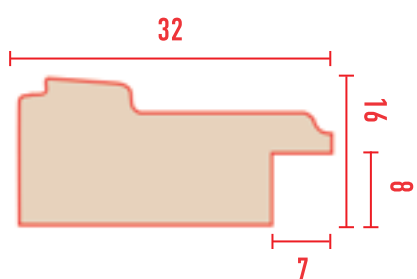

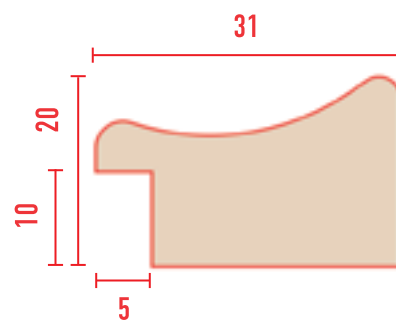
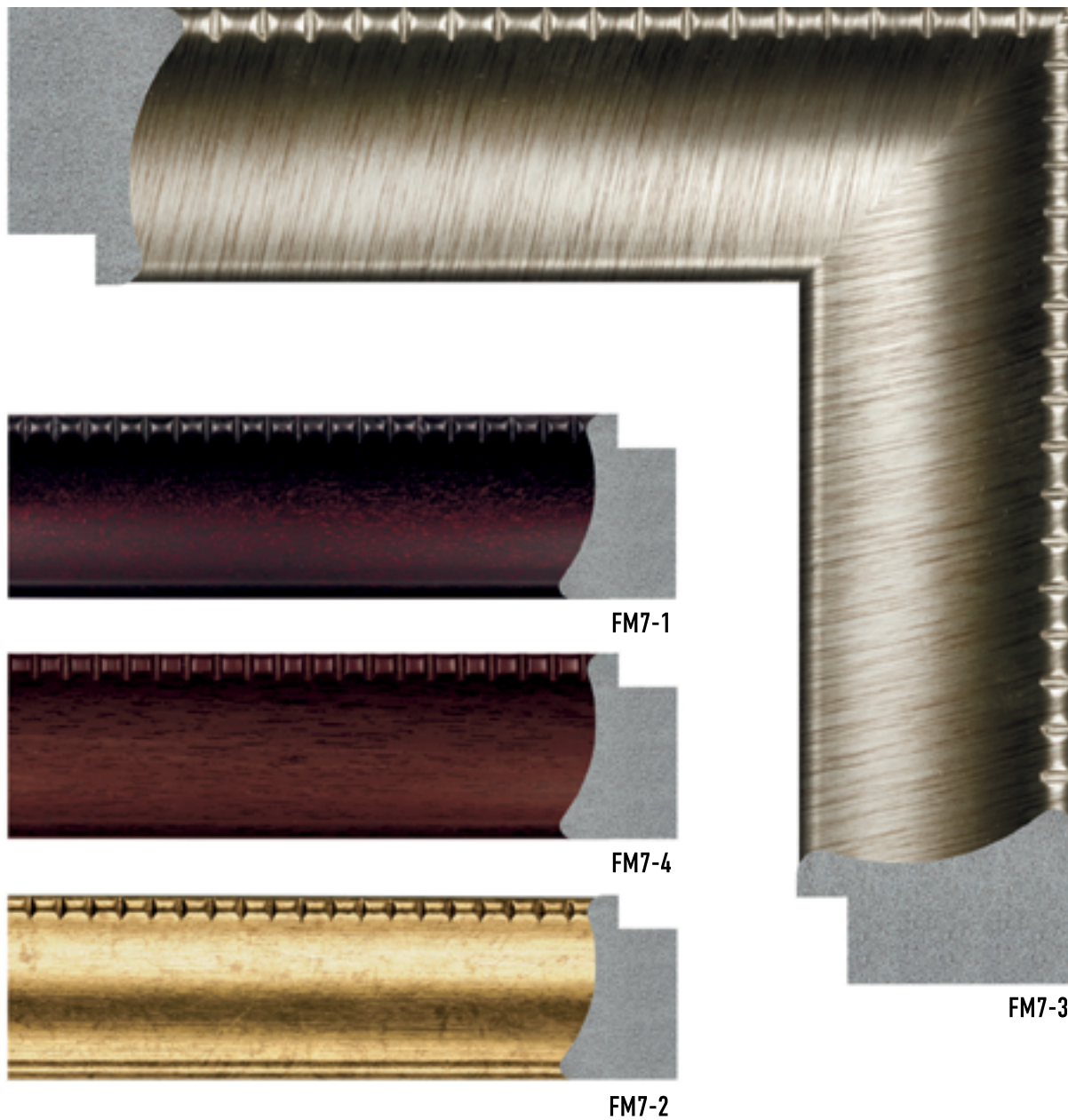



коллекция

ЭКЛЕКТИКА



FM2-1

FM2-3

FM2-2

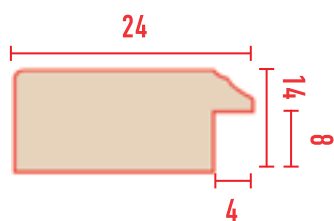

Артикул	Стр.	Артикул	Стр.	Артикул	Стр.	Артикул	Стр.	Артикул	Стр.	Артикул	Стр.
102-13	59	158-3	62	304-126	35	556-6	39	807-60	49	FM9-2	72
102-15	59	158-4	62	304-127	35	564-277	57	807-966	48	FM9-3	72
102-17	60	158-40	64	304-566	35	564-278	57	808-176N	36	FM9-4	72
102-18	59	158-41	64	400-954	10	564-280	57	808-176S	36	FM9-5	72
102-19	59	158-42	64	400-956	10	566-1223	30	808-552	36	FM10-1	78
102-20	59	158-43	64	400-958	10	566-1224	30	808-553	36	FM10-2	78
102-28	60	158-44	64	413-182	13	577-1223	28	811M-905	27	FM10-3	78
102-29	60	158-5	62	413-494	13	577-966	28	811M-906	27	FM10-4	78
102-51	60	158-54	63	413-565	13	582-26	26	829-294	34	FM10-5	78
102-52	60	158-55	62	413-566	13	582-27	26	829-934	34	FM11-1	75
102-53	60	158-552	63	413-919	13	582-440	26	829-935	34	FM11-2	75
108-17	29	158-553	63	477-114	46	582-433	26	849-373	16	FM12-1	82
108-18	29	158-6	62	477-1243	46	582-438	26	849-565	16	FM12-2	82
108-19	29	158-7D	62	477-1244	46	583-22	61	849-566	16	FM14-1	76
108-20	29	158-767	62	477-195	46	583-28	61	849-919	16	FM15-1	81
108-28	29	158-933	62	516-126	19	583-29	61	868-645	17	FM15-2	81
108-29	29	158-937	62	516-127	19	584-1069	58	916-247	11	FM16-1	88
109-11	53	159B-565	68	516-1069	18	584-1070	58	916-393	11	FM16-2	88
109-13	53	159D-552	69	516-1070	19	651-176	56	916-397	11	FM17-1	80
109-15	53	159D-553	69	516-1333	18	651-176S	56	916-461	11	FM17-2	80
109-17	52	175-1	37	516-767	19	685-126	47	927-252	14	FM18-1	83
109-18	52	175-2	37	524-1069	32	685-127	47	947-565	4	FM18-2	83
109-19	52	175-3	37	524-1070	32	685-182	47	947-566	4	FM18-3	83
109-20	52	175-4	37	524-1333	32	685-217	47	947-954	4	FM18-4	83
109-28	52	175-5	37	527-114	24	685-221	47	947-956	4	FM19-1	79
109-29	52	175-6	37	527-1243	24	686M-565	43	978-565	25	FM19-2	79
117-438	67	176-1	33	527-1244	24	686M-566	43	978-566	25	FM20-1	86
117-552	67	176-2	33	527-195	24	690-182	31	980-565	7	FM20-2	86
117-553	67	176-3	33	527-725	24	690-198	31	980-566	7	FM21-1	77
118-17	70	176-4	33	528-114	44	696-182	23	FM2-1	90	FM21-2	77
118-18	70	176-5	33	528-1243	44	696-401	23	FM2-2	90	FM22-1	71
118-19	70	176-6	33	528-1244	44	807-1	50	FM2-3	90	FM22-2	71
118-20	70	198-11	41	528-195	44	807-1223	48	FM3-1	87	FM22-3	71
118-28	70	198-13	41	534-11	55	807-18D	49	FM3-2	87	FM22-4	71
118-29	70	198-14	41	534-13	55	807-19D	49	FM3-3	87	J11-115	42
119-34	65	198-15	41	534-14	55	807-2	50	FM4-1	74	J11-1223	42
119-35	65	214-3	12	534-15	55	807-3	50	FM4-2	74	J11-1224	42
119-36	65	214-373	12	534-51	55	807-4	50	FM4-3	74	J11-966	42
119-37	65	214-6	12	534-52	55	807-40	51	FM4-4	74	J12-1223	54
119-38	65	228-565	21	534-53	55	807-41	51	FM5-1	84	J12-1224	54
149-954	66	228-566	21	548M-440	38	807-42	51	FM5-2	84	J12-966	54
149-955	66	228-650	21	552-114	20	807-43	51	FM5-3	84	J13-1223	45
149-956	66	229-1068	9	552-1153	20	807-44	51	FM6-1	85	J13-1224	45
158-1	62	229-1223	8	552-195	20	807-5	50	FM6-2	85	J13-966	45
158-1028	63	229-182	9	552-373	20	807-56	48	FM7-1	89	S16-1223	5
158-1084	63	229-645	8	553-114	40	807-57	48	FM7-2	89	S16-966	5
158-115	63	229-955	8	553-1153	40	807-58	48	FM7-3	89	S18-1223	22
158-118	63	229-966	8	553-195	40	807-59	49	FM7-4	89	S18-122	22
158-126	63	230-1223	6	553-373	40	807-552	50	FM8-1	73	S18-966	22
158-127	63	230-966	6	556-2	39	807-553	50	FM8-2	73		
158-281	63	293-752	15	556-4	39	807-6	51	FM9-1	72		

